

Lantech

IES-0204FT

4-port 10/100TX + 2-port 100FX

Industrial Switch

User Manual



Rev.1.01
21-Jan-2008

FCC Warning

This Equipment has been tested and found to comply with the limits for a Class A digital device, pursuant to Part 15 of the FCC rules. These limits are designed to provide reasonable protection against harmful interference in a residential installation. This equipment generates, uses, and can radiate radio frequency energy. It may cause harmful interference to radio communications if the equipment is not installed and used in accordance with the instructions. However, there is no guarantee that interference will not occur in a particular installation. If this equipment does cause harmful interference to radio or television reception, which can be determined by turning the equipment off and on, the user is encouraged to try to correct the interference by one or more of the following measures:

- Reorient or relocate the receiving antenna.
- Increase the separation between the equipment and receiver.
- Connect the equipment into an outlet on a circuit different from that to which the receiver is connected.
- Consult the dealer or an experienced radio/TV technician for help.

CE Mark Warning

This is a class A product. In a domestic environment this product may cause radio interference in which case the user may be required to take adequate measures.

Content

FCC Warning	ii
CE Mark Warning.....	ii
Overview	1
Introduction.....	1
Features	3
Packing List	4
Safety Precaution	4
Hardware Description.....	5
Front Panel.....	5
Top View	6
Wiring the Power Inputs.....	6
Wiring the Fault Alarm Contact	7
LED Indicators	7
DIP switch	8
Ports.....	8
Cabling	10
Mounting Installation	12

DIN-Rail Mounting	12
Wall Mount Plate Mounting	14
Hardware Installation	15
Installation Steps	16
Troubles shooting.....	17
Technical Specification	18

Overview

Introduction

The 4 10/100TX 2 100FX Industrial Switch is a cost-effective solution and meets the high reliability requirements demanded by industrial applications.

High-Speed Transmissions

The 4 10/100TX + 2 100FX Industrial Switch provides you with Fiber port for your fiber optic cable to make a long-distance connection. The 4 10/100TX + 2 100FX Industrial Switch includes a switch controller that can automatically sense transmission speeds (10/100 Mbps). The RJ-45 interface can also be auto-detected, so MDI or MDI-X is automatically selected and a crossover cable is not required. All Ethernet ports have memory buffers that support the store-and-forward mechanism. This assures that data is properly transmitted.

Dual Power Input

To reduce the risk of power failure, the 4 10/100TX + 2 100FX Industrial Switch provides +9 ~ +56 V_{DC} dual power inputs. If there is power failure, 4 10/100TX + 2 100FX Industrial Switch will automatically switch to the secondary power input.

Flexible Mounting

4 10/100TX + 2 100FX Industrial Switch is extremely compact and can be mounted on a DIN-rail or a panel, so it is suitable for any space-constrained environment.

Operating Temperature

The operating temperature of the 4 10/100TX + 2 100FX Industrial Switch is between -20 ~ 60°C (-E model: -40 ~ 75°C), you can use the 4 10/100TX + 2 100FX Industrial Switch in some of the harshest industrial environments that exist.

Easy Troubleshooting

LED indicators make troubleshooting quick and easy. Each 10/100 Base-TX port has 2 LEDs that display the link status, transmission speed and collision status. Also the three power indicators P1, P2 and Fault help you diagnose immediately.

Features

- Provides 4 x 10/100TX + 2 x 100FX Mbps Ethernet ports
- TX ports support full/half duplex flow control
- Supports MDI/MDI-X auto-crossover
- Embedded with a switch controller, supports auto-negotiation
- Supports store & forward transmission
- Supports redundant +9 ~ +56 V_{DC} power input
- Provides flexible mounting: DIN-rail, Wall Mounting
- 4 x 10/100TX + 2 x 100FX Industrial Switch can operate in the range of temperature between -20 ~ 60°C (-E model: -40 ~ 75°C).

Packing List

- 1 x 4-port 10/100TX + 2-port 100FX Industrial Switch
- 1 x User manual
- 2 x Wall Mounting Bracket and Screws

Safety Precaution

Attention IF DC voltage is supplied by an external circuit, please use a protection device on the power supply input.

Hardware Description

In this paragraph, we will introduce the Industrial switch's hardware spec, port, cabling information, and wiring installation.

Front Panel

The Front Panel of the 4-port 10/100TX +2-port 100FX Industrial Switch is shown as follows.

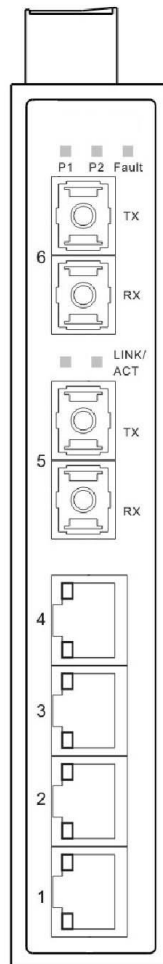

Front Panel of the 4-port 10/100TX + 2-port 100FX Industrial Switch

Top View

The top panel of the 4-port 10/100TX + 2-port 100FX Industrial Switch is equipped one terminal block connector of two power inputs.

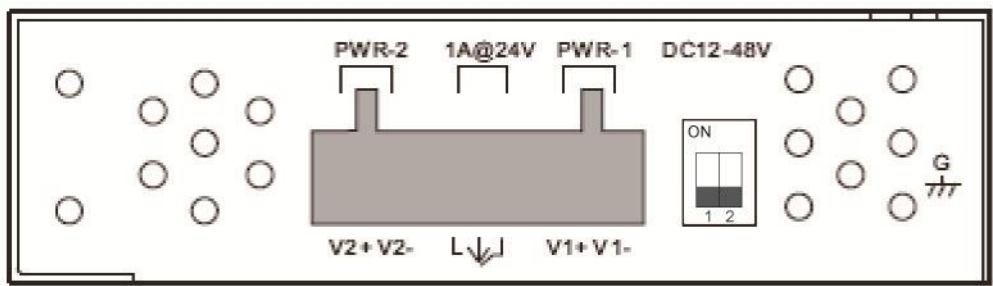

Top Panel of the 4-port 10/100TX + 2-port 100FX Industrial Switch

Wiring the Power Inputs

Please follow the steps below to insert the power wire.

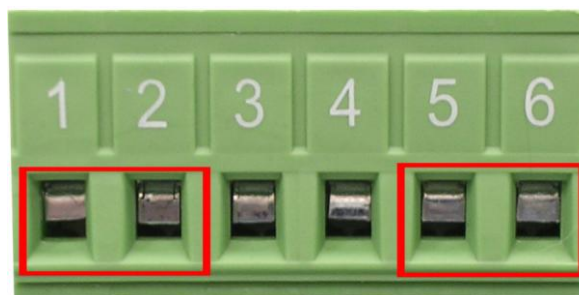

V2+ V2-

V1+ V1-

1. Insert the positive and negative wires into the V+ and V- contacts on the terminal block connector.

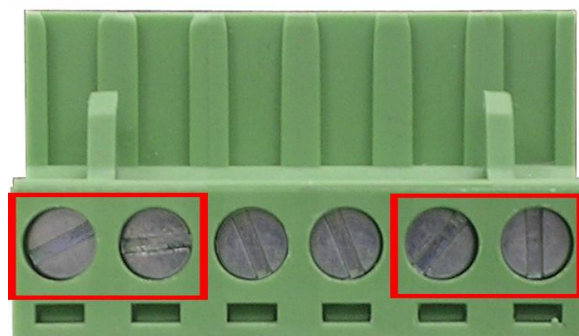

2. To tighten the wire-clamp screws for preventing the wires to loose.

Wiring the Fault Alarm Contact

The fault alarm contact is in the middle of terminal block connector as the picture shows below. Inserting the wires, it will detect the fault status which the power is failure or port link failure (for managed model) and form an open circuit.

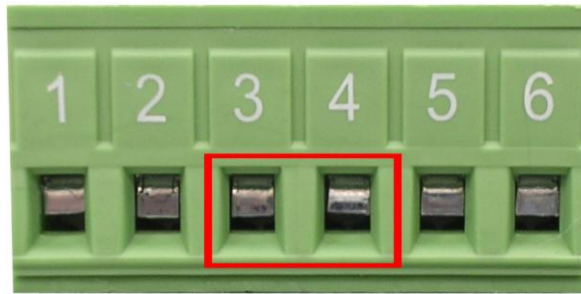

Insert the wires into the fault alarm contact (No. 3 & 4)

Note *The wire gauge for the terminal block should be in the range between 12~ 24 AWG.*

LED Indicators

There are few LEDs display the power status and network status located on the front panel of the Industrial switch, each of them has its own specific meaning as the table below.

LED	Color	Description	
P1	Green	On	Power input 1 is active
		Off	Power input 1 is inactive
P2	Green	On	Power input 2 is active
		Off	Power input 2 is inactive
Fault	Red	On	Power input 1 or 2 is inactive
		Off	Power input 1 and 2 are both active, or no power input
Link/Active	Green	On	Connected to network

(1~5 for 1 x 100FX)		Flashing	Networking is active
(1~6 for 2 x 100FX)		Off	Not connected to network
Duplex/Collision (1~4)	Orange	On	Ethernet port full duplex
		Flashing	Collision of packets occurs
		Off	Ethernet port half duplex or not connect to network

DIP switch

The DIP-Switch is used to configure power alarm. The default value of DIP-switch is **OFF**.

DIP	Status	Description
1	ON	Enable Power 1 Alarm
	OFF	Disable Power 1 Alarm
2	ON	Enable Power 2 Alarm
	OFF	Disable Power 2 Alarm

Ports

RJ-45 ports (Auto MDI/MDIX): The RJ-45 ports are auto-sensing for 10Base-T or 100Base-TX devices connections. Auto MDI/MDIX means that you can connect to another switch or workstation without changing straight through or crossover cabling. See figures as below for straight through and crossover cable schematic.

■ RJ-45 Pin Assignments

Pin Number	Assignment
1	Tx+
2	Tx-
3	Rx+
6	Rx-

Note “+” and “-” signs represent the polarity of the wires that make up each wire pair.

All ports on this industrial switch support automatic MDI/MDI-X operation, you can use straight-through cables (See Figure below) for all network connections to PCs or servers, or to other switches or hubs. In straight-through cable, pins 1, 2, 3, and 6, at one end of the cable, are connected straight through to pins 1, 2, 3 and 6 at the other end of the cable. The table below shows the 10BASE-T/ 100BASE-TX MDI and MDI-X port pin outs.

Pin MDI-X	Signal Name	MDI Signal Name
1	Receive Data plus (RD+)	Transmit Data plus (TD+)
2	Receive Data minus (RD-)	Transmit Data minus (TD-)
3	Transmit Data plus (TD+)	Receive Data plus (RD+)
6	Transmit Data minus (TD-)	Receive Data minus (RD-)

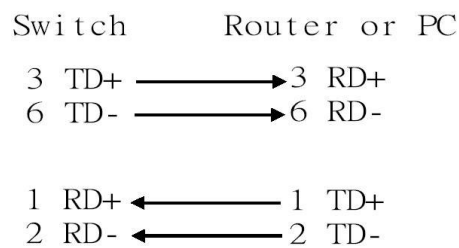

Straight Through Cable Schematic

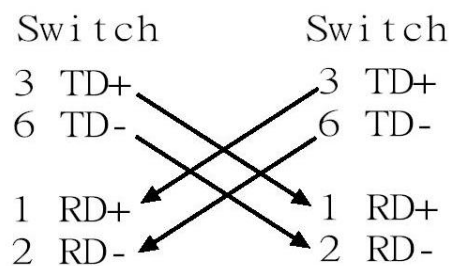

Cross Over Cable Schematic

■ **Fiber Port**

The fiber port of SC type connector can work in multi mode (2Km) or single mode (30Km).

When you connect the fiber port to another one, please follow the figure below to connect accordingly. Wrong connection will cause the port cannot work normally.

[Multi-Mode] power budget : Min: 9dB , MAX: 19dB.

[Single-Mode] power budget : Min: 19dB , MAX: 26dB.

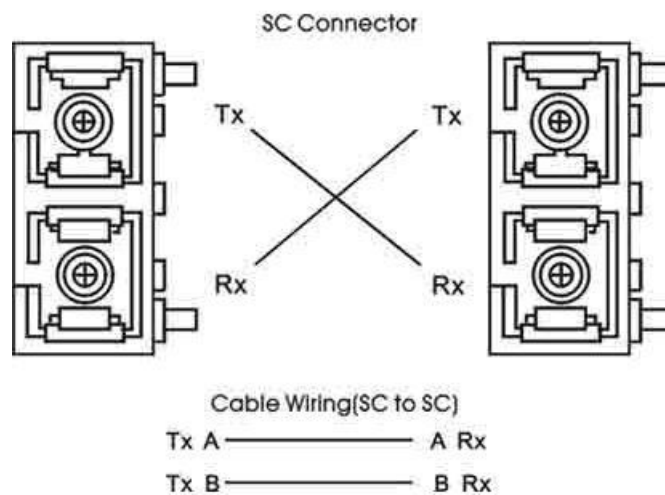

ATTENTION



This is a Class 1 Laser/LED product. Don't stare into the Laser/LED Beam.

Cabling

- Using four twisted-pair, Category 5 cabling for RJ-45 port connection. The cable between the switch and the link partner (switch, hub, workstation, etc.) must be less than 100 meters (328 ft.) long.

- Fiber segment using **single-mode** connector type must use 9/125 μ m single-mode fiber cable. User can connect two devices in the distance up to **30 Kilometers**.
- Fiber segment using **multi-mode** connector type must use 50 or 62.5/125 μ m multi-mode fiber cable. User can connect two devices up to **2Km** distances.

Mounting Installation

DIN-Rail Mounting

The DIN-Rail is screwed on the industrial switch when out of factory. If the DIN-Rail is not screwed on the industrial switch, please see the following figure to screw the DIN-Rail on the switch. Follow the steps below to hang the industrial switch.

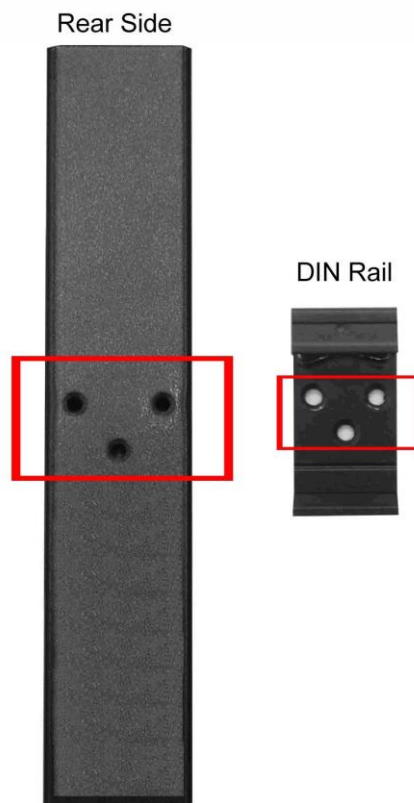

1. Use the screws to screw on the DIN-Rail on the industrial switch
2. To remove the DIN-Rail, reverse the step 1.

3. Insert the top of DIN-Rail into the track.

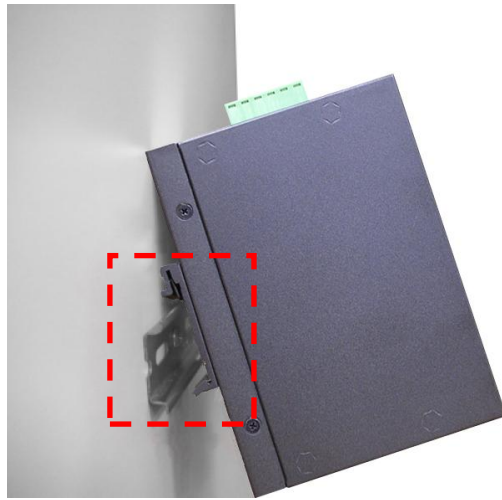

4. Then, lightly push the button of DIN-Rail into the track.

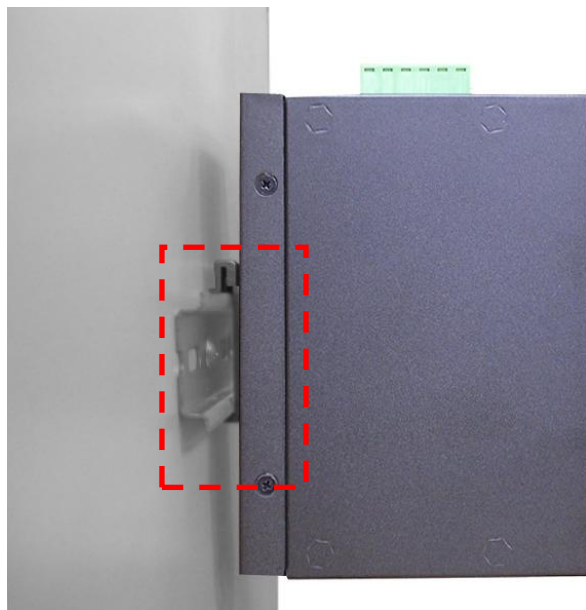

5. Check the DIN-Rail is tightly on the track.
6. To remove the industrial switch from the track, reverse the steps above.

Wall Mount Plate Mounting

Follow the steps below to mount the industrial switch with wall mount plate.

1. Remove the DIN-Rail from the industrial switch; loose the screws to remove the DIN-Rail.
2. Place the wall mount plate on the top & bottom side of the industrial switch.
3. Use the screws to screw the wall mount plate on the industrial switch.
4. Use the hook holes at the corners of the wall mount plate to hang the industrial switch on the wall.
5. To remove the wall mount plate, reverse the steps above.

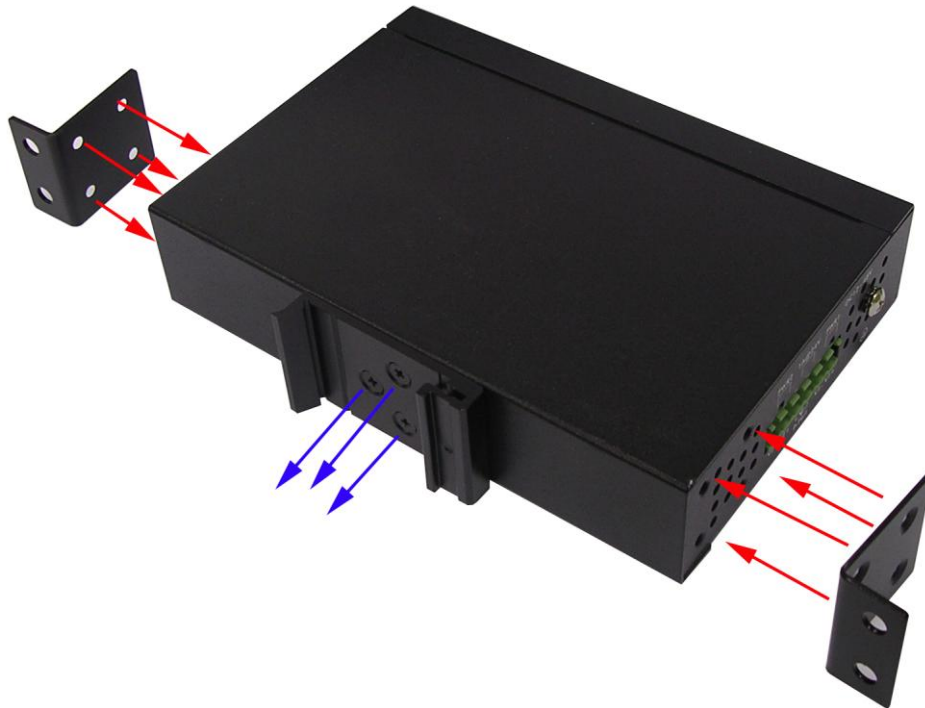

Hardware Installation

In this paragraph, we will describe how to install the 4-port 10/100TX + 2-port 100FX Industrial Switch and the installation points for the attention.

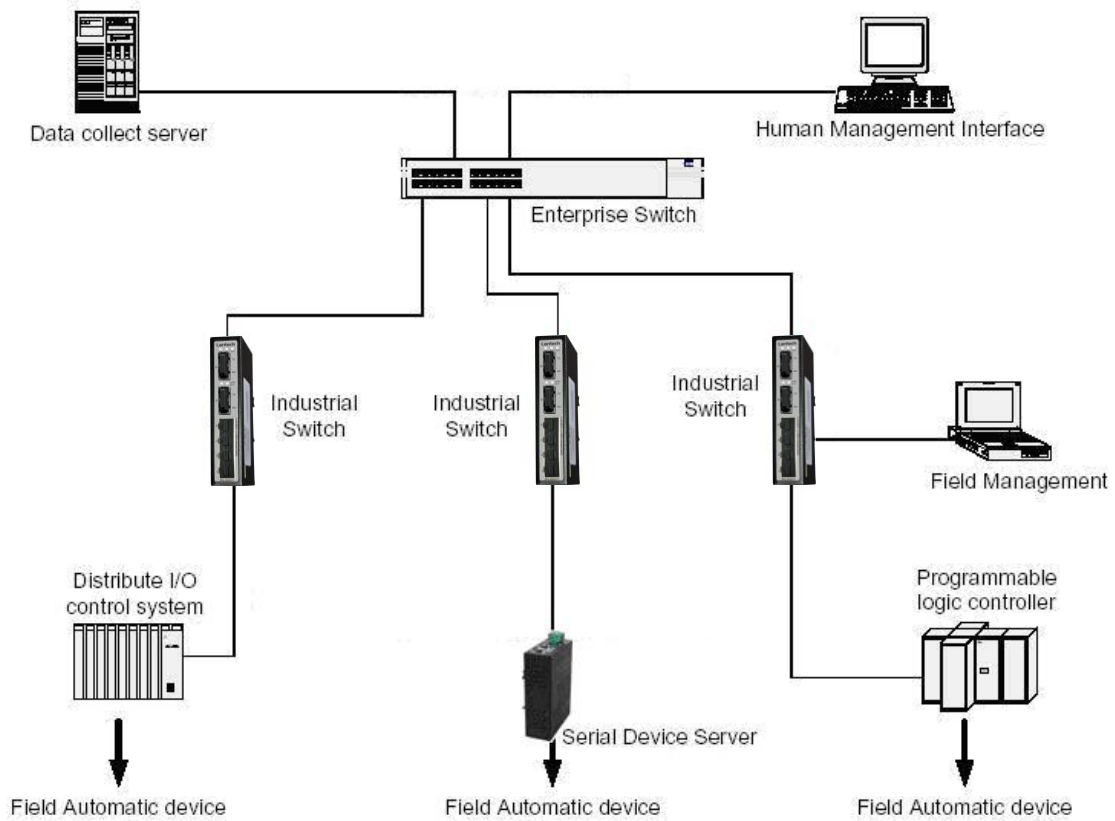

Installation Steps

1. Unpack the Industrial switch packing.
2. Check the DIN-Rail is screwed on the Industrial switch. If the DIN-Rail is not screwed on the Industrial switch. Please refer to **DIN-Rail Mounting** section for DIN-Rail installation. If you want to wall mount the Industrial switch, then please refer to **Wall Mount Plate Mounting** section for wall mount plate installation.
3. To hang the Industrial switch on the DIN-Rail track or wall, please refer to the **Mounting Installation** section.
4. Power on the Industrial switch. How to wire the power; please refer to the **Wiring the Power Inputs** section. The power LED on the Industrial switch will light up. Please refer to the **LED Indicators** section for meaning of LED lights.
5. Prepare the twisted-pair, straight through Category 5 cable for Ethernet connection.
6. Insert one side of Category 5 cables into the Industrial switch Ethernet port (RJ-45 port) and another side of category 5 cables to the network devices' Ethernet port (RJ-45 port), ex: switch, PC or Server. The UTP port (RJ-45) LED on the Industrial switch will light up when the cable connected with the network device. Please refer to the **LED Indicators** section for LED light meaning.
7. When all connections are all set and LED lights all show in normal, the installation is complete.

Troubleshooting

- Verify that you are using the right power cord/adaptor. Please don't use the power adapter output higher than the power input of this switch, or it will burn this switch down.
- Select the proper UTP/STP cable to construct your network. Please check that you are using the right cable. Use unshielded twisted-pair (UTP) or shield twisted-pair (STP) cable for RJ-45 connections: 100Ω Category 3, 4, or 5 cable for 10Mbps connections or 100Ω Category 5 cable for 100Mbps connections. Also be sure that the length of any twisted-pair connection does not exceed 100 meters (328 feet).
- **Diagnosing LED Indicators:** To assist in identifying problems, the switch can be easily monitored through panel indicators, which describe common problems the user may encounter and where the user can find possible solutions.
- IF the power indicator does not light on when the power cord is plugged in, you may have a problem with power cord. Then check for loose power connections, power losses or surges at power outlet. IF you still cannot resolve the problem, contact your local dealer for assistance.
- If the LED indicators are normal with the correctly connected cables and the packets still cannot transmit, please check your system's Ethernet devices' configuration or status.

Technical Specification

The technical specifications of the Industrial Switch are listed as follows.

Hardware Specification	
IEEE Standards	IEEE 802.3 10Base-T Ethernet IEEE 802.3u 100Base-TX and 100Base-FX Fast Ethernet IEEE802.3x Flow Control
Transfer Rate	14,880pps for Ethernet port 148,800pps for Fast Ethernet port
Mac Address	2K MAC address table
Connectors	10/100TX: 4 x RJ-45 with auto MDI/MDI-X function 100M fiber: 2 x SC type connector for Single-mode or Multi-mode type fiber cable [Multi-Mode] power budget : Min: 9dB , MAX: 19dB. [Single-Mode] power budget : Min: 19dB , MAX: 26dB.
Network Cable	10Base-T: 2-pair UTP/STP Cat. 3, 4, 5 cable EIA/TIA-568 100-ohm (100m) 100Base-TX: 2-pair UTP/STP Cat. 5 cable EIA/TIA-568 100-ohm (100m)
Optical Cable	Multi-mode: 50/125um~62.5/125um Single-mode: 9/125um Available distance: 2km (Multi-mode)/30km (Single-mode) Wavelength: 1310nm (Multi-mode/Single-mode)
Protocol	CSMA/CD
DIP Switch	DIP Switch 1: Enable/Disable Power Fault alarm DIP Switch 2: Enable/Disable Power Fault alarm
LED	Per port: Link/Activity (Green), Full duplex/Collision (Amber) Per unit: Power 1 (Green), Power 2 (Green), Fault(Amber)

Reserve polarity protection	Present
Overload current protection	Present
Power Supply	9~56VDC, 12~36 VAC*, Redundant power with polarity reverse protect function and removable terminal block
Power Consumption	7 Watts
Operating Humidity	5% ~ 95% (Non-condensing)
Operating Temperature	-20°C~60°C / -4°F~140°F (Standard model) -40°C~75°C / -40°F~167°F (-E model)
Storage Temperature	-40°C~85°C / -40°F~185°F
Case Dimension	Metal case. IP-30, 26.1mm (W) x 94.9mm (D) x 144.3mm (H)
Weight	382 g
Installation	DIN Rail and Wall Mount Design
EMI & EMS	FCC Part 15, CISPR (EN55022) class A EN61000-4-2 (ESD), EN61000-4-3 (RS), EN61000-4-4 (EFT), EN61000-4-5 (Surge), EN61000-4-6 (CS), EN61000-4-8, EN61000-4-11
Safety	CE/EN60950-1
Stability Testing	IEC60068-2-32 (Free fall) IEC60068-2-27 (Shock) IEC60068-2-6 (Vibration)
MTBF	668,306 hrs
Warranty	5 years
*Optional	