

LGS-2624C-DNV

**20 10/100/1000T + 4 100/1000M
SFP Combo + 2 100/1000M SFP L2
Plus Managed Switch**

User Manual



DNV Type Approval for Ships, Craft and Off-shore Platforms

v1.02
APR 2015

The information in this document is subject to change without notice. Unless the explicit written permission of Manufacture Corporation, this document in whole or in part shall not be replicated or modified or amended or transmitted, in any form, or by any means manual, electric, electronic, electromagnetic, mechanical, optical or otherwise for any purpose.

DURATION OF HARDWARE WARRANTY

HARDWARE: In accordance with the provisions described under, Manufacture Corporation (hereinafter called "Manufacture") warrants its hardware products (hereinafter referred to as "Product") specified herein to be for a period of twelve (12) months from the date of shipment.

Should a Product fail to perform during the effective warranty period as described above, Manufacture shall replace the defective Product or part, or delivering a functionally equivalent Product or part in receipt of customer's request, provided that the customer complies with the return material authorization (RMA) procedures and returns all defective Product prior to installation of the replacements to Manufacture.

All defective Products must be returned to Manufacture with issuance of a Return Material Authorization number (RMA number) assigned to the reseller from whom the end customer originally purchased the Product. The reseller is responsible for ensuring the shipments are insured, with the transportation charges prepaid and the RMA number clearly marked on the outside of the package. Manufacture will not accept collect shipments or those returned without an RMA number.

Manufacture shall not be responsible for any software, firmware, information or memory data contained in, stored on or integrated with any Product returned to Manufacture pursuant to any warranty.

EXCLUSIONS. The warranty as mentioned above does not apply to the following conditions, in Manufacture's judgment, it contains (1) customer does not comply with the manual instructions offered by Manufacture in installation, operation, repair or maintenance, (2) Product fails due to damage from unusual external or electrical stress, shipment, storage, accident, abuse or misuse, (3) Product is used in an extra hazardous environment or activities, (4) any serial number on the Product has been removed or defaced, (5) this warranty will be of no effect if the repair is via anyone other than Manufacture or the approved agents, or (6) In the event of any failures or delays by either party hereto in the performance of all or any part of this agreement due to acts of God, war, riot, insurrection, national emergency, strike, embargo, storm, earthquake, or other natural forces, or by the acts of anyone not a party to this agreement, or by the inability to secure materials or transportation, then the party so affected shall be executed from any further performance for a period of time after the occurrence as may reasonably be necessary to remedy the effects of that occurrence, but in no event more than sixty (60) days. If any of the stated events should occur, Party A shall promptly notify Party B in writing as soon as commercially practicable, but in no event more than twenty (20) business days and provide documentation evidencing such occurrence. In no event shall the maximum liability of Manufacture under this warranty exceed the purchase price of the Product covered by this warranty.

DISCLAIMER. EXCEPT AS SPECIFICALLY PROVIDED ABOVE AS REQUIRED "AS IS" AND THE WARRANTIES AND REMEDIES STATED ABOVE ARE EXCLUSIVE AND IN LIEU OF ALL OTHERS, ORAL OR WRITTEN, EXPRESS OR IMPLIED. ANY AND ALL OTHER WARRANTIES, INCLUDING IMPLIED WARRANTIES OF MERCHANTABILITY, FITNESS FOR A PARTICULAR PURPOSE AND NONINFRINGEMENT OR THIRD PARTY RIGHTS ARE EXPRESSLY EXCLUDED.

MANUFACTURE SOFTWARE LICENSE AGREEMENT

NOTICE: Please carefully read this Software License Agreement (hereinafter referred to as this "Agreement") before copying or using the accompanying software or installing the hardware unit with pre-enabled software or firmware (each of which is referred to as "Software" in this Agreement). BY COPYING OR USING THE SOFTWARE, YOU ACCEPT ALL OF THE PROVISIONS AND CONDITIONS OF THIS AGREEMENT. THE PROVISIONS EXPRESSED IN THIS AGREEMENT ARE THE ONLY PROVISION UNDER WHICH MANUFACTURE WILL PERMIT YOU TO USE THE SOFTWARE. If you do not accept these provisions and conditions, please immediately return the unused software, manual and the related product. Written approval is **NOT** a prerequisite to the validity or enforceability of this Agreement and no solicitation of any such written approval by or on behalf of Manufacture shall be deemed as an inference to the contrary.

LICENSE GRANT. The end user (hereinafter referred to as "Licensee") of the Software is granted a personal, non-sublicensable, nonexclusive, nontransferable license by Manufacture Corporation ("Manufacture"): (1) To use the Manufacture's software ("Software") in object code form solely on a single central processing unit owned or leased by Licensee or otherwise embedded in the equipment offered by Manufacture. (2) To copy the Software only for backup purposes in support of authorized use of the Software. (3) To use and copy the documentation related to the Software solely in support of authorized use of the Software by Licensee. The License applies to the Software only except other Manufacture's software or hardware products. Without the prior written consent of Manufacture, Licensee has no right to receive any source code or design documentation with respect to the Software.

RESTRICTIONS ON USE; RESERVATION OF RIGHTS. The Software and related documentation are protected under copyright laws. Manufacture and/or its licensors retain all title and ownership in both the Software and its related documentation, including any revisions made by Manufacture. The copyright notice must be reproduced and included with any copy of any portion of the Software or related documentation. Except as expressly authorized above, Licensee shall not copy or transfer the Software or related documentation, in whole or in part. Licensee also shall not modify, translate, decompile, disassemble, use for any competitive analysis, reverse compile or reverse assemble all or any portion of the Software, related documentation or any copy. The Software and related documentation embody Manufacture's confidential and proprietary intellectual property. Licensee is not allowed to disclose the Software, or any information about the operation, design, performance or implementation of the Software and related documentation that is confidential to Manufacture to any third party. Software and related documentation may be delivered to you subject to export authorization required by governments of Taiwan and other countries. You agree that you will not export or re-export any Software or related documentation without the proper export licenses required by the governments of affected countries.

LIMITED SOFTWARE WARRANTY. Manufacture warrants that any media on which the Software is recorded will be free from defects in materials under normal use for a period of twelve (12) months from date of shipment. If a defect in any such media should occur during the effective warranty period, the media may be returned to Manufacture, then Manufacture will replace the media. Manufacture shall not be responsible for the replacement of media if the failure of the media results from accident, abuse or misapplication of the media.

EXCLUSIONS. The warranty as mentioned above does not apply to the Software, which (1) customer does not comply with the manual instructions offered by Manufacture in installation, operation, or maintenance, (2) Product fails due to damage from unusual external or electrical stress, shipment, storage, accident, abuse or misuse, (3) Product is used in an extra hazardous environment or activities, (4) any serial number on the Product has been removed or defaced, or (5) this warranty will be of no effect if the repair is via anyone other than Manufacture or the authorized agents. The maximum liability of Manufacture under this warranty is confined to the purchase price of the Product covered by this warranty.

DISCLAIMER. EXCEPT AS PROVIDED ABOVE, THE SOFTWARE IS PROVIDED "AS IS " AND MANUFACTURE AND ITS LICENSORS MAKE NO WARRANTIES, EXPRESS OR IMPLIED, WITH REPSECT TO THE SOFTWARE AND DOCUMENTAITON. MANUFACTURE AND ITS LICENSORS DISCLAIM ALL OTHER WARRANTIES, INCLUSIVE OF WITHOUT LIMITATION, IMPLIED WARRANTIES OR MERCHANTABILITY, FITNESS FOR A PARTICULAR PURPOSE AND NONINFRINGEMENT. FURTHER, MANUFACTURE DOES NOT WARRANT, GUARANTEE, OR MAKE ANY REPRESENTATIONS REGARDING THE USE, OR THE RESULTS OF THE USE, OF THE SOFTWARE OR RELATED WRITTEN DOCUMENTAITON IN TERMS OF CORRECTNESS, ACCURACY, RELIABILITY, OR OTHERWISE.

CONSEQUENTIAL DAMAGES. IN NO EVENT SHALL MANUFACTURE OR ITS AUTHORIZED RESELLER BE LIABLE TO LICENSEE OR ANY THIRD PARTY FOR (A) ANY MATTER BEYOND ITS REASONABLE CONTROL OR (B) ANY CONSEQUENTIAL, SPECIAL, INDIRECT OR INCIDENTAL DAMAGES ARISING OUT OF THIS LICENSE OR USE OF THE SOFTWARE PROVIDED BY MANUFACTURE. EVEN IF MANUFACTURE HAS BEEN NOTIFIED OF THE POSSIBILITY OF SUCH DAMAGES IN ADVANCE. IN NO EVENT SHALL THE LIABILITY OF MANUFACTURE IN CONNECTION WITH THE SOFTWARE OR THIS AGREEMENT EXCEED THE PRICE PAID TO MANUFACTURE FOR THE LICENSE.

TERM AND TERMINATION. The License is effective until terminated; however, all of the restrictions in regard to Manufacture's copyright in the Software and related documentation will cease being effective at the date of expiration; Notwithstanding the termination or expiration of the term of this agreement, it is acknowledged and agreed that those obligations relating to use and disclosure of Manufacture's confidential information shall survive. Licensee may terminate this License at any time by destroying the software together with all copies thereof. This License will be immediately terminated if Licensee fails to comply with any term and condition of the Agreement. Upon any termination of this License for any reason, Licensee shall discontinue to use the Software and shall destroy or return all copies of the Software and the related documentation.

GENERAL. This License shall be governed by and construed pursuant to the laws of Taiwan. If any portion hereof is held to be invalid or unenforceable, the remaining provisions of this License shall remain in full force and effect. Neither the License nor this Agreement is assignable or transferable by Licensee without Manufacture's prior written consent; any attempt to do so shall be void. This License constitutes the entire License between the parties with respect to the use of the Software.

LICENSEE ACKNOWLEDGES THAT LICENSEE HAS READ THIS AGREEMENT, UNDERSTANDS IT, AND AGREES TO BE BOUND BY ITS TERMS AND CONDITIONS. LICENSEE FURTHER AGREES THAT THIS AGREEMENT IS THE ENTIRE AND EXCLUSIVE AGREEMENT BETWEEN MANUFACTURE AND LICENSEE.

Table of Contents

A. OPERATION OF WEB-BASED MANAGEMENT.....	10
1. SYSTEM.....	7
1-1 SYSTEM INFORMATION.....	7
1-1.1 Information.....	7
1-1.2 Configuration.....	1
1-1.3 CPU Load.....	1
1-2 TIME.....	2
1-2.1 Manual.....	2
1-2.2 NTP.....	4
1-3 ACCOUNT.....	6
1-3.1 Users.....	6
1-3.1.1 Add User.....	8
1-3.1.2 Privitege Level.....	9
1-4 IP.....	11
1-4.1 IPV4.....	11
1-4.2 IPV6.....	13
1-5 SYSLOG.....	15
1-5.1 Configuration.....	15
1-5.2 Log.....	17
1-5.3 Detailed Log.....	18
1-6 SNMP.....	19
1-6.1 System.....	19
1-6.2 Communities.....	21
1-6.3 Users.....	22
1-6.4 Groups.....	24
1-6.5 Views.....	25
1-6.6 Access.....	27
1-6.7 Tarp.....	29
2. CONFIGURATION.....	31
2-1 PORT.....	31
2-1.1 Configuration.....	31
2-1.2 Port Description.....	33
2-1.3 Traffic Overview.....	34
2-1.4 Detailed Statistics.....	35
2-1.5 Qos Statistics.....	38
2-1.6 SFP Information.....	40
2-1.7 EEE.....	42
2-2 ACL.....	44
2-2.1 Ports.....	44
2-2.2 Rate Limiters.....	46
2-2.3 Access Control List.....	47
2-2.4 ACL Ststus.....	50
2-3 AGGREGATION.....	52
2-3.1 Static Trunk.....	52
2-3.1.1 Static Trunk.....	52
2-3.2 LACP.....	54
2-3.2.1 Configuration.....	54
2-3.2.2 System Status.....	56
2-3.2.3 Port Status.....	57

2-3.2.4 Port Statistics	59
2-4 SPANNING TREE	60
2-4.1 Bridge Settings	60
2-4.2 MSTI Mapping	62
2-4.3 MSTI Priorities.....	65
2-4.4 CIST Ports	66
2-4.5 MSTI Ports.....	68
2-4.6 Bridge Status.....	70
2-4.7 Port Status.....	71
2-4.8 Port Statistics	72
2-5 IGMP SNOOPING	73
2-5.1 Basic Configuration.....	73
2-5.2 VLAN Configuration.....	75
2-5.3 Port Group Filtering.....	77
2-5.4 Status	79
2-5.5 Group Information.....	81
2-5.6 IPv4 SSM information	82
2-6 MLD SNOOPING	84
2-6.1 Basic Configuration.....	84
2-6.2 VLAN Configuration.....	87
2-6.3 Port Group Filtering.....	89
2-6.4 Status	90
2-6.5 Group Information.....	92
2-6.6 IPv6 SSM Information	92
2-7 MVR	95
2-7.1 Configuration.....	95
2-7.2 Groups Information	96
2-7.3 Statistics.....	97
2-8 LLDP	97
2-8.1 LLDP Configuration.....	98
2-8.2 LLDP Neighbours.....	102
2-8.3 LLDP-MED Configuration	104
2-8.4 LLDP-MED Neighbours.....	113
2-8.5 EEE	118
2-8.6 Port Statistics	120
2-9 FILTERING DATA BASE.....	122
2-9.1 Configuration.....	122
2-9.2 Status	125
2-10 VLAN.....	126
2-10.1 VLAN Membership	126
2-10.2 Ports	128
2-10.3 Switch Status	130
2-10.4 Port Status.....	132
2-10.5 Private VLANs.....	134
2-10.5.1 Private VLANs Membership.....	134
2-10.5.2 MAC-based VLAN.....	137
2-11.5.3 Protocol -based VLAN.....	140
2-11 VOICE VLAN	144
2-11.1 Configuration	144
2-11.2 OUI.....	147
2-12 GARP	148
2-12.1 Configuration.....	148
2-12.2 Statistics.....	151
2-13 GVRP	152
2-13.1 Configuration.....	152
2-13.2 Statistics.....	154

2-14 MRP	155
2-14.1 Configuration	155
2-14.2 Statistics	157
2-15 MVRP	158
2-15.1 Configuration	158
2-15.2 Statistics	160
2-16 QoS	161
2-16.1 Port Classification	161
2-16.2 Port Schedulers	163
2-16.3 Port Shapers	164
2-16.4 Port Tag Remarking	165
2-16.5 Port DSCP	166
2-16.7 DSCP Translation	169
2-16.8 DSCP Classification	171
2-16.9 QoS Control List Configuration	172
2-16.10 QCL Status	176
2-16.11 Storm Control	178
2-17 THERMAL PROTECTION	179
2-17.1 Status	180
2-18 MIRROR	181
2-19 TRAP EVENT SEVERITY	183
2-20 SMTP CONFIGURATION	183
3. SECURITY	185
3-1 IPSOURCE GUARD	185
3-1.1 Configuration	185
3-1.2 Static Table	187
3-1.3 Dynamic Table	188
3-2 ARP INSPECTION	189
3-2.1 Configuration	189
3-2.2 Static Table	190
3-2.3 Dynamic Table	191
3-3 DHCP SNOOPING	192
3-3.1 Configuration	192
3-3.2 Statistics	193
3-4 DHCP RELAY	195
3-4.1 Configuration	195
3-4.2 Statistics	197
3-5 NAS	199
3-5.1 Configuration	199
3-5.2 Switch Status	208
3-5.3 Port Status	210
3-6 AAA	213
3-6.1 Configuration	213
3-6.2 Radius Overview	217
3-6.3 Radius Details	219
3-7 PORT SECURITY	220
3-7.1 Limit Control	220
3-7.2 Switch Status	223
3-7.3 Port Status	225
3-8 ACCESS MANAGEMENT	227
3-8.1 Configuration	227
3-8.2 Configuration	229
3-9 SSH	230
3-10 HTTPS	231
3-11 AUTH METHOD	232

4. MAINTENANCE	233
4-1 RESTART DEVICE	233
4-2 FIRMWARE UPGRADE	234
4-3 SAVE / RESTORE	235
4-3.1 <i>Factory Defaults</i>	235
4-3.2 <i>Save Start</i>	236
4-3.3 <i>Save User</i>	237
4-3.4 <i>Restore User</i>	238
4-4 EXPORT / IMPORT	239
4-4.1 <i>Export Config</i>	239
4-4.2 <i>Import Config</i>	240
4-5 DIAGNOSTICS.....	241
4-5.1 <i>Ping</i>	241
4-5.2 <i>Ping6</i>	243
4-5.3 <i>VeriPHY</i>	244
B.GLOSSARY OF WEB-BASED MANAGEMENT	245
A.....	245
C.....	247
D.....	FLOW 247
E.....	249
F.....	249
H.....	250
I.....	250
L.....	252
M.....	253
N.....	254
O.....	255
P.....	255
Q.....	257
R.....	257
S.....	258
T.....	260
U.....	261
V.....	262

Revision History

Release	Date	Revision
V0.91	08/12/2011	A1
V1.01	07/03/2014	A2
V1.02	04/21/2015	

About this user's manual

In this user's manual, it will not only tell you how to install and connect your network system but configure and monitor the LGS-2624C-DNV through the built-in CLI and web by (RJ-45) serial interface and Ethernet ports step-by-step. Many explanation in detail of hardware and software functions are shown as well as the examples of the operation for web-based interface and command-line interface (CLI).

Overview of this user's manual

- Chapter 1 "Installation". "Operation of Web-based Management"
- Chapter 2 "Maintenance"

Installation

RJ-45 Cabling

Use four twisted-pair, Category 5e or above cabling for RJ-45 port connection. The cable between the switch and the link partner (switch, hub, workstation, etc.) must be less than 100 meters (328 ft.) long. The RJ-45 copper ports will auto-sense for 10Base-T, 100Base-TX, or 1000Base-T connections. Auto MDI/MDIX means that the switch can connect to another switch or workstation without changing straight through or crossover cabling.

■ 10/100Base-TX Pinouts

Pin Number	MDI-X Signal Name	MDI Signal Name
1	Receive Data plus (RD+)	Transmit Data plus (TD+)
2	Receive Data minus (RD-)	Transmit Data minus (TD-)
3	Transmit Data plus (TD+)	Receive Data plus (RD+)
6	Transmit Data minus (TD-)	Receive Data minus (RD-)

[Note] “+” and “-” signs represent the polarity of the wires that make up each wire pair.

■ 10/100Base-TX Cable Schema

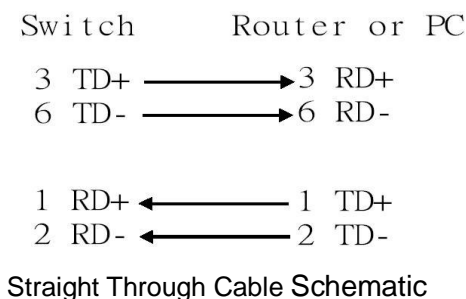

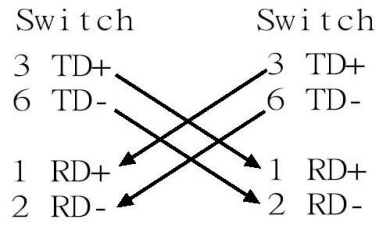

Cross Over Cable Schematic

■ **10/100/1000Base-T Pinouts**

The table below describes the gigabit Ethernet RJ-45 pinouts.

Pin	Signal name	Description
1	BI_DA+	Bi-directional pair A+
2	BI_DA-	Bi-directional pair A-
3	BI_DB+	Bi-directional pair B+
4	BI_DC+	Bi-directional pair C+
5	BI_DC-	Bi-directional pair C-
6	BI_DB-	Bi-directional pair B-
7	BI_DD+	Bi-directional pair D+
8	BI_DD-	Bi-directional pair D-

■ **10/100/1000Base-T Cable Schema**

The following two figures illustrate the 10/100/1000Base-T cable schema.

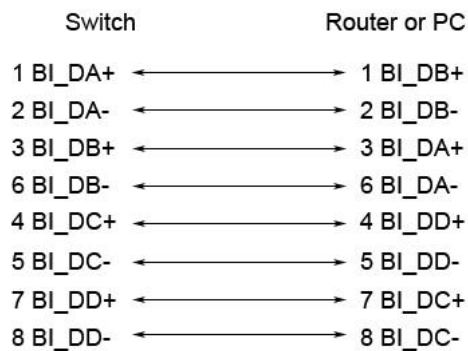

Straight Through Cable Schema

SFP Cabling

SFP Connection

To connect the transceiver and the LC cable, please follow the steps shown below:

First, insert the transceiver into the SFP slot. Notice that the triangle mark indicates the bottom of the slot.

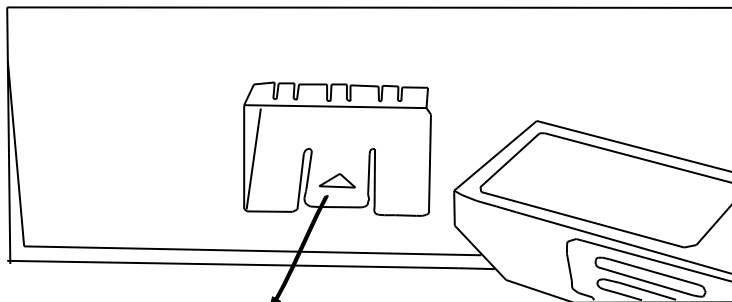

triangle mark
Insert transceiver into the SFP slot

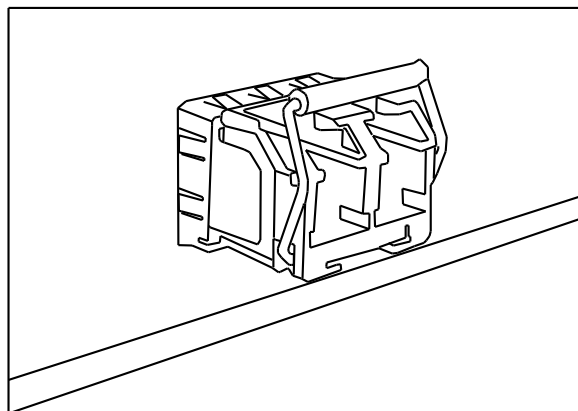

Transceiver Inserted

Second, insert LC connector of the fiber cable into the transceiver.

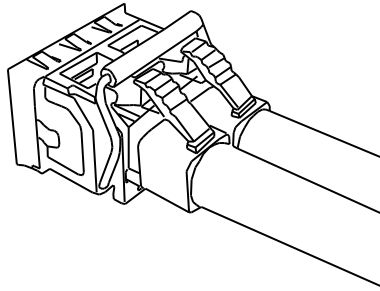

LC connector to the transceiver

SFP Disconnection

To remove the LC connector from the transceiver, please follow the steps below:

First, press down the latches and pull the LC connector out of the transceiver.

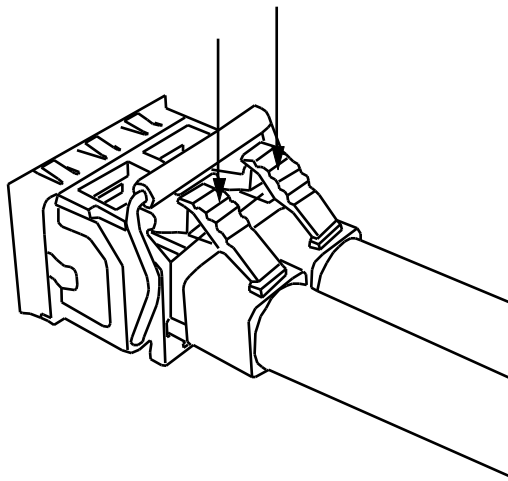

Press down the latches to remove the LC connector

Second, push down the metal loop and pull out the transceiver by the handle.

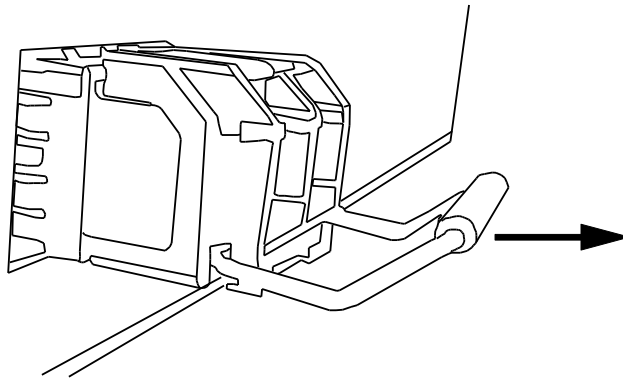

Pull the transceiver out of the slot

Wall Mounting

To hang the Ethernet switch on the wall, please follow the steps below.

1. Prepare the 4 wall-mount plates and **M3 screws (long 4mm)** included.
2. Align the screw holes between the wall-mount plates and the unit as the figure illustrated.
3. Secure the plates to the unit with the accompanying screws.

Rack Mounting

When installing the LGS-2624C-DNV switch in a 19 inch rack, it must always be mounted horizontally with the top side up, This procedure requires the following items:

- Eight bracket screws (included with the switch)
- Four equipment rack brackets for panel installation(included with the switch)



Panel installation kit X4



2 kits for each side

Operation of Web-based Management

This chapter instructs you how to configure and manage the LGS-2624C-DNV through the web user interface . With this facility, you can easily access and monitor through any one port of the switch all the status of the switch, including MIBs status, each port activity, Spanning tree status, port aggregation status, multicast traffic, VLAN and priority status, even illegal access record and so on.

The default values of the managed switch are listed in the table below:

IP Address	192.168.1.1
Subnet Mask	255.255.255.0
Default Gateway	192.168.1.254
Username	admin
Password	

After the managed switch has been finished configuration the switch's serial interface, you can browse it. For instance, type <http://192.168.1.1> in the address row in a browser, it will show the following screen (see Fig.3-1) and ask you inputting username and password in order to login and access authentication. The default username and password are both "admin". For the first time to use, please enter the default username and password, then click the **<Login>** button. The login process now is completed.

In this login menu, you have to input the complete username and password respectively, the switch will not give you a shortcut to username automatically. This looks inconvenient, but safer.

In the switch, it supports a simple user management function allowing only one administrator to configure the system at the same time. If there are two or more users using administrator's identity, the switch will allow the only one who logins first to configure the system. The rest of users, even with administrator's identity, can only monitor the system. For those who have no administrator's identity, can only monitor the system. There are only a maximum of three users able to login simultaneously in the switch.

Note :When you login the swith WEB/CLI to manager.You must first type the Username of the admin. Password was blank, so when you type after the end Username, please press enter. Management page to enter WEB/CLI.

Note : AS LGS-2624C-DNV the function enable dhcp, so If you do not have DHCP server to provide ip addressesto the switch, the Switch default ip 192.168.1.1

Note : When you login LGS-2624C-DNV switch Web UI management, you can use both ipv4 ipv6 login to manage

To optimize the display effect, we recommend you use Microsoft IE 6.0 above, Netscape V7.1 above or FireFox V1.00 above and have the resolution 1024x768.

The switch supported neutral web browser interface.

for example, left section is the whole function tree with web user interface and we will travel it through this chapter.

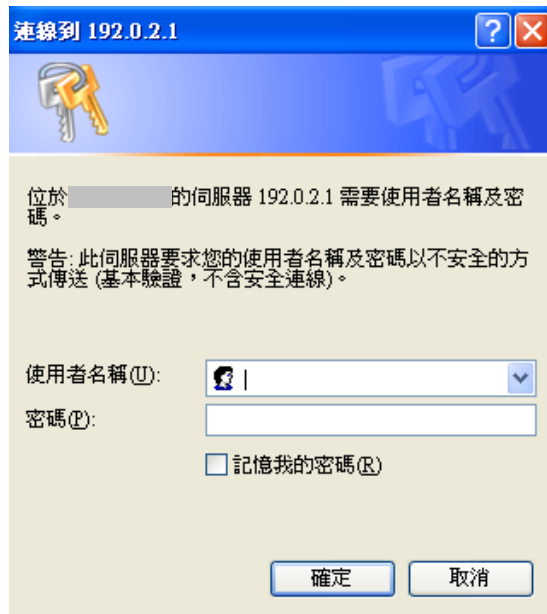

1. System

This chapter describes all of the basic configuration tasks which includes the System Information and any manage of the Switch(e.g. Time, Account, IP, Syslog and SNMP.)

1-1 System Information

After you login, the switch shows you the system information . This page is default and tells you the basic information of the system, including “Model Name”, “System Description”, “Contact”, “Device Name”, “System Up Time”, “BIOS Version”, “Firmware Version”, “Hardware-Mechanical Version”, “Serial Number”, “Host IP Address”, “Host Mac Address”, “Device Port”, “RAM Size” , “Flash Size” and. With this information, you will know the software version used, MAC address, serial number, how many ports good and so on. This is helpful while malfunctioning.

1-1.1 Information

The switch system information is provided here.

Web interface

To configure System Information in the web interface:

1. Click SYSTEM, System, Information.
2. Specify the contact information for the system administrator as well as the name and location of the switch. Also indicate the local time zone by configuring the appropriate offset.
3. Click Refresh

System Information

Model Name	LGS-2624C
System Description	8-Port 10/100/1000Base-T + 2 TP/(100/1G) SFP Combo L2 Plus Managed Switch
Location	
Contact	
Device Name	LGS-2624C
System Date	2011-01-01 00:01:46
System Uptime	0d 00:01:46
BIOS Version	v1.00
Firmware Version	v0 87
Hardware-Mechanical Version	v1.00-v1.00
Series Number	TIM0123456789
Host IP Address	192.168.5.112
Subnet Mask	255.255.255.0
Gateway IP Address	0.0.0.0
Host MAC Address	00-01-c1-00-00-00
Console Baudrate	115200
RAM Size	64MB
Flash Size	16MB
Bridge FDB Size	8192 MAC Addresses
Transmit Queue	8 queues per port
Maximum Frame Size	9600

Parameter description:

Contact

The system contact configured in Configuration System Information | System Contact.

Name

The system name configured in Configuration System Information System Name.

Location

The system location configured in Configuration System Information System Location.

Chip ID

The Chip ID of this switch.

MAC Address

The MAC Address of this switch.

System Date

The current (GMT) system time and date. The system time is obtained through the configured SNTP Server, if any.

System Uptime

The period of time the device has been operational.

Software Version

The software version of the switch.

Software Date

The date when the switch software was produced.

1-1.2 Configuration

You can identify the system by configuring the contact information, name, and location of the switch.

Web interface

To configure System Information in the web interface:

1. Click System, System Information, Configuration.
2. Write System Contact , System Name, System Location information in this page.
3. Click Save

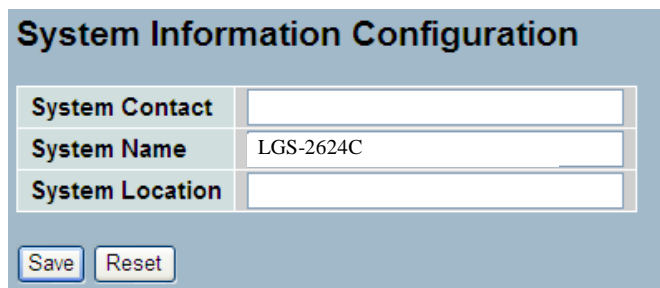

System Information Configuration	
System Contact	<input type="text"/>
System Name	LGS-2624C
System Location	<input type="text"/>

Parameter description:

System Contact

The textual identification of the contact person for this managed node, together with information on how to contact this person. The allowed string length is 0 to 255, and the allowed content is the ASCII characters from 32 to 126.

System Name

An administratively assigned name for this managed node. By convention, this is the node's fully-qualified domain name. A domain name is a text string drawn from the alphabet (A-Za-z), digits (0-9), minus sign (-). No space characters are permitted as part of a name. The first character must be an alpha character. And the first or last character must not be a minus sign. The allowed string length is 0 to 255.

System Location

The physical location of this node(e.g., telephone closet, 3rd floor). The allowed string length is 0 to 255, and the allowed content is the ASCII characters from 32 to 126.

1-1.3 CPU Load

This page displays the CPU load, using an SVG graph

Web Interface

To configure System Information in the web interface:

1. Click System, System Information, CPU Load .
2. Display the CPU Load on the screen
3. Click Auto-refresh .

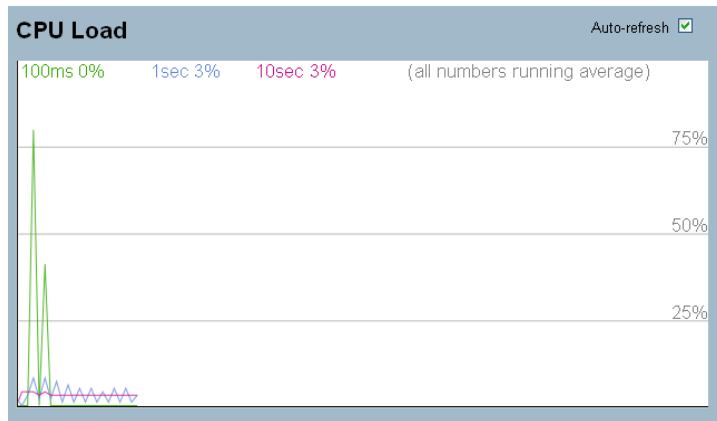

Parameter description:

The load is measured as averaged over the last 100ms, 1sec and 10 seconds intervals. The last 120 samples are graphed, and the last numbers are displayed as text as well.

In order to display the SVG graph, your browser must support the SVG format. Consult the SVG Wiki for more information on browser support. Specifically, at the time of writing, Microsoft Internet Explorer will need to have a plugin installed to support SVG.

Note :CPU Load is using SVG (Scalable Vector Graphics) to display the chart and this feature is only available on MS IE 9.0 & above or Firefox v4.0 & above.

1-2 Time

This page configure the switch Time. Time configure is including Time Configuration and NTP Configuration

1-2.1 Manual

The switch provides manual and automatic ways to set the system time via NTP. Manual setting is simple and you just input "Year", "Month", "Day", "Hour", "Minute" and "Second" within the valid value range indicated in each item.

Web Interface

To configure Time in the web interface:

1. Click Time , Manual.
2. Specify the Time parameter in manual parameters.
3. Click Save.

Time Configuration	
Clock Source:	<input checked="" type="radio"/> Use Local Settings <input type="radio"/> Use NTP Server
Local Time:	2011-01-01 00:10:20 YYYY-MM-DD HH:MM:SS
Time Zone Offset:	0 min
Daylight Savings	<input type="checkbox"/> Enable
Time Set Offset:	60 min. (Range: 1 - 1440, Default: 60)
Daylight Savings Type:	<input checked="" type="radio"/> By dates <input type="radio"/> Recurring
From:	YYYY-MM-DD HH:MM
To:	YYYY-MM-DD HH:MM
From:	Day: Sun Week: First Month: Jan Time: 00:00 HH:MM
To:	Day: Sun Week: First Month: Jan Time: 00:00 HH:MM
Save Reset	

Parameter description:

Local Time:

Show the current time of the system.

Timezone Offset

Provide the timezone offset relative to UTC/GMT. The offset is given in minutes east of GMT. The valid range is from -720 to 720 minutes.

Daylight Saving:

Daylight saving is adopted in some countries. If set, it will adjust the time lag or in advance in unit of hours, according to the starting date and the ending date. For example, if you set the day light saving to be 1 hour. When the time passes over the starting time, the system time will be increased one hour after one minute at the time since it passed over. And when the time passes over the ending time, the system time will be decreased one hour after one minute at the time since it passed over.

The switch supports valid configurable day light saving time is $-5 \sim +5$ step one hour. The zero for this parameter means it need not have to adjust current time, equivalent to in-act daylight saving. You don't have to set the starting/ending date as well. If you set daylight saving to be non-zero, you have to set the starting/ending date as well; otherwise, the daylight saving function will not be activated.

1-2.2 NTP

NTP is Network Time Protocol and is used to sync the network time based Greenwich Mean Time (GMT). If use the NTP mode and select a built-in NTP time server or manually specify an user-defined NTP server as well as Time Zone, the switch will sync the time in a short after pressing <Apply> button. Though it synchronizes the time automatically, NTP does not update the time periodically without user's processing.

Time Zone is an offset time off GMT. You have to select the time zone first and then perform time sync via NTP because the switch will combine this time zone offset and updated NTP time to come out the local time, otherwise, you will not able to get the correct time. The switch supports configurable time zone from -12 to +13 step 1 hour.

Default Time zone: +8 Hrs.

Web Interface

To configure Time in the web interface:

1. Click SYSTEM, NTP.
2. Specify the Time parameter in manual parameters.
3. Click Save.

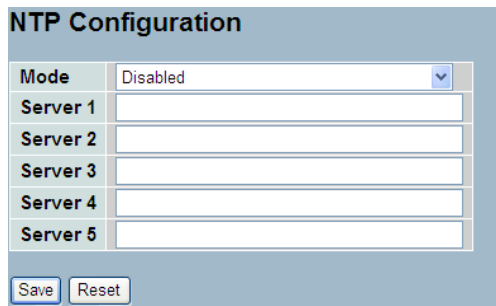

NTP Configuration	
Mode	Disabled
Server 1	
Server 2	
Server 3	
Server 4	
Server 5	
Save	Reset

Parameter description:

Mode

Indicates the NTP mode operation. Possible modes are:

Enabled: Enable NTP mode operation. When NTP mode operation is enabled, the agent forwards NTP messages between the clients and the server when they are not on the same subnet domain.

Disabled: Disable NTP mode operation.

Server 1to 5

Provide the NTP IPv4 or IPv6 address of this switch. IPv6 address is in 128-bit records represented as eight fields of up to four hexadecimal digits with a colon separating each field (:). For example, 'fe80::215:c5ff:fe03:4dc7'. The symbol '::' is a special syntax that can be used as a shorthand way of representing multiple 16-bit groups of contiguous zeros; but it can only appear once. It can also represent a legally valid IPv4 address. For example, '::192.1.2.34'.

Buttons

These buttons are displayed on the NTP page:

Save – Click to save changes.

Reset - Click to undo any changes made locally and revert to previously saved values.

1-3 Account

In this function, only administrator can create, modify or delete the username and password. Administrator can modify other guest identities' password without confirming the password but it is necessary to modify the administrator-equivalent identity. Guest-equivalent identity can modify his password only. Please note that you must confirm administrator/guest identity in the field of Authorization in advance before configuring the username and password. Only one administrator is allowed to exist and unable to be deleted. In addition, up to 4 guest accounts can be created.

1-3.1 Users

This page provides an overview of the current users. Currently the only way to login as another user on the web server is to close and reopen the browser

Web Interface

To configure Account in the web interface:

1. Click SYSTEM, Account, Users.
2. Specify the User Name parameter.
3. Click Save.

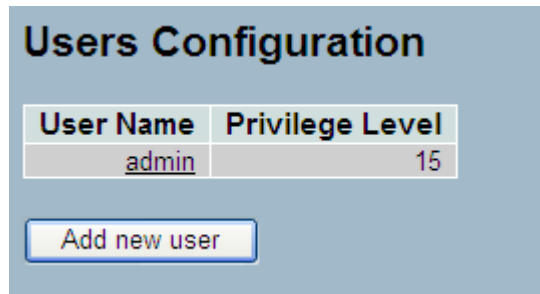

Parameter description:

User Name

The name identifying the user. This is also a link to Add/Edit User.

Privilege Level

The privilege level of the user. The allowed range is 1 to 15. If the privilege level value is 15, it can access all groups, i.e. that is granted the fully control of the device. But others value need to refer to each group privilege level. User's privilege should be same or greater than the group privilege level to have the access of that group. By default setting, most groups privilege level 5 has the read-only access and privilege level 10 has the read-write access. And the system maintenance (software upload, factory defaults and etc.) need user privilege level 15. Generally, the privilege level 15 can be used for an administrator account, privilege level 10 for a standard user account and privilege level 5 for a guest account.

1-3.1.1 Add User

This page configures a user. The switch provides different users.

Web Interface

To configure Account in the web interface:

1. Click SYSTEM, Account, Users, Add new user
2. Specify the User Name, Password parameter.
3. Click Save.

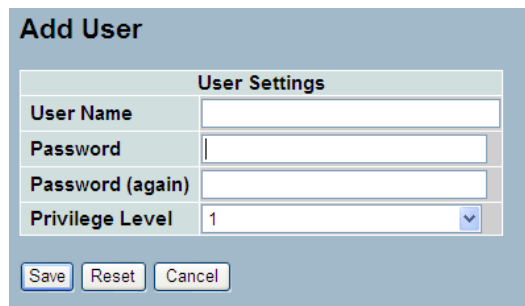

The screenshot shows a web interface titled "Add User". It contains a "User Settings" section with four input fields: "User Name", "Password", "Password (again)", and "Privilege Level". The "Privilege Level" field is a dropdown menu currently set to "1". Below the form are three buttons: "Save", "Reset", and "Cancel".

Parameter description:

User Name

The name identifying the user.

Password

The password of the user.

Privilege Level

The privilege level of the user. The allowed range is 1 to 15. If the privilege level value is 15, it can access all groups, i.e. that is granted the fully control of the device. But others value need to refer to each group privilege level. User's privilege should be same or greater than the group privilege level to have the access of that group. By default setting, most groups privilege level 5 has the read-only access and privilege level 10 has the read-write access. And the system maintenance (software upload, factory defaults and etc.) need user privilege level 15. Generally, the privilege level 15 can be used for an administrator account, privilege level 10 for a standard user account and privilege level 5 for a guest account.

1-3.1.2 Privilege Level

This page provides an overview of the privilege levels. The switch provides user set Account, Aggregation, Diagnostics, EEE, GARP, GVRP, IP, IPMC Snooping LACP LLDP LLDP MED MAC Table MRP MVR MVRP Maintenance Mirroring POE Ports Private VLANs QoS SMTP SNMP Security Spanning Tree System Trap Event VCL VLANs Voice VLAN Privilege Levels form 1 to 15 .

Web Interface

To configure Privilege Level in the web interface:

1. Click SYSTEM, Account, Privilege Level.
2. Specify the Privilege parameter.
3. Click Save.

Group Name	Privilege Levels
Aggregation	10
Debug	15
Diagnostics	10
DualCPU	10
EEE	10
IP	10
IPMC_Snooping	10
LACP	10
LLDP	10
LLDP_MED	10
MAC_Table	10
MRP	10
MVR	10
MVRP	10
Maintenance	15

Parameter description:

Group Name

The name identifying the privilege group. In most cases, a privilege level group consists of a single module (e.g. LACP, RSTP or QoS), but a few of them contains more than one. The following description defines these privilege level groups in details:

System: Contact, Name, Location, Timezone, Log.

Security: Authentication, System Access Management, Port (contains Dot1x port, MAC based and the MAC Address Limit), ACL, HTTPS, SSH, ARP Inspection and IP source guard.

IP: Everything except 'ping'.

Port: Everything except 'VeriPHY'.

Diagnostics: 'ping' and 'VeriPHY'.

Maintenance: CLI- System Reboot, System Restore Default, System Password, Configuration Save, Configuration Load and Firmware Load.

Web- Users, Privilege Levels and everything in Maintenance.

Debug: Only present in CLI.

Privilege Levels

Every group has an authorization Privilege level for the following sub groups: configuration read-only, configuration/execute read-write, status/statistics read-only, status/statistics read-write (e.g. for clearing of statistics). User Privilege should be same or greater than the authorization Privilege level to have the access to that group.

1-4 IP

IP is an acronym for **I**nternet **P**rotocol. It is a protocol used for communicating data across an internet network.

IP is a "best effort" system, which means that no packet of information sent over is assured to reach its destination in the same condition it was sent. Each device connected to a Local Area Network (LAN) or Wide Area Network (WAN) is given an Internet Protocol address, and this IP address is used to identify the device uniquely among all other devices connected to the extended network.

The current version of the Internet protocol is IPv4, which has 32-bits Internet Protocol addresses allowing for in excess of four billion unique addresses. This number is reduced drastically by the practice of webmasters taking addresses in large blocks, the bulk of which remain unused. There is a rather substantial movement to adopt a new version of the Internet Protocol, IPv6, which would have 128-bits Internet Protocol addresses. This number can be represented roughly by a three with thirty-nine zeroes after it. However, IPv4 is still the protocol of choice for most of the Internet.

1-4.1 IPV4

The IPv4 address for the switch could be obtained via DHCP Server for VLAN 1. To manually configure an address, you need to change the switch's default settings to values that are compatible with your network. You may also need to establish a default gateway between the switch and management stations that exist on another network segment.

Configure the switch-managed IP information on this page
The Configured column is used to view or change the IP configuration.
The Current column is used to show the active IP configuration.

Web Interface

To configure an IP address in the web interface:

1. Click System, IP Configuration.
2. Specify the IPv4 settings, and enable DNS proxy service if required.
3. Click Save.

IP Configuration

	Configured	Current
DHCP Client	<input type="checkbox"/>	Renew
IP Address	192.168.1.1	192.168.1.1
IP Mask	255.255.255.0	255.255.255.0
IP Router	0.0.0.0	0.0.0.0
VLAN ID	1	1
DNS Server	0.0.0.0	0.0.0.0

IP DNS Proxy Configuration

DNS Proxy

Save Reset

Parameter description:

DHCP Client

Enable the DHCP client by checking this box. If DHCP fails and the configured IP address is zero, DHCP will retry. If DHCP fails and the configured IP address is non-zero, DHCP will stop and the configured IP settings will be used. The DHCP client will announce the configured System Name as hostname to provide DNS lookup.

IP Address

Provide the IP address of this switch in dotted decimal notation.

IP Mask

Provide the IP mask of this switch dotted decimal notation.

IP Router

Provide the IP address of the router in dotted decimal notation.

SNTP Server

Provide the IP address of the SNTP Server in dotted decimal notation.

DNS Server

Provide the IP address of the DNS Server in dotted decimal notation.

VLAN ID

Provide the managed VLAN ID. The allowed range is 1 to 4095.

DNS Proxy

When DNS proxy is enabled, DUT will relay DNS requests to the current configured DNS server on DUT, and reply as a DNS resolver to the client device on the network.

1-4.2 IPV6

This section describes how to configure the switch-managed IPv6 information. The Configured column is used to view or change the IPv6 configuration. And the Current column is used to show the active IPv6 configuration.

Configure the switch-managed IPv6 information on this page.
The Configured column is used to view or change the IPv6 configuration.
The Current column is used to show the active IPv6 configuration.

Web Interface

To configure Management IPv6 of the switch in the web interface:

1. Click System, IPv6 Configuration.
2. Specify the IPv6 settings, and enable Auto Configuration service if required.
3. Click Save.

	Configured	Current
Auto Configuration	<input type="checkbox"/>	Renew
Address	::192.0.2.1	:::192.0.2.1 Link-Local Address: fe80::6082:cdb9:19ab:c0e2
Prefix	96	96
Router	::	::

Save Reset

Parameter description:

Auto Configuration

Enable IPv6 auto-configuration by checking this box. If fails, the configured IPv6 address is zero. The router may delay responding to a router solicitation for a few seconds, the total time needed to complete auto-configuration can be significantly longer.

Address

Provide the IPv6 address of this switch. IPv6 address is in 128-bit records represented as eight fields of up to four hexadecimal digits with a colon separating each field (:). For example, 'fe80::215:c5ff:fe03:4dc7'. The symbol '::' is a special syntax that can be used as a shorthand way of representing multiple 16-bit groups of contiguous zeros; but it can only appear once. It can also represent a legally valid IPv4 address. For example, ':::192.1.2.34'.

Prefix

Provide the IPv6 Prefix of this switch. The allowed range is 1 to 128.

Router

Provide the IPv6 gateway address of this switch. IPv6 address is in 128-bit records represented as eight fields of up to four hexadecimal digits with a colon separating each field (:). For example, 'fe80::215:c5ff:fe03:4dc7'. The symbol '::' is a special syntax that can be used as a shorthand way of representing multiple 16-bit groups of contiguous zeros; but it can only appear once. It can also represent a legally valid IPv4 address. . For example, '::192.1.2.34'.

1-5 Syslog

The Syslog is a standard for logging program messages . It allows separation of the software that generates messages from the system that stores them and the software that reports and analyzes them. It can be used as well a generalized informational, analysis and debugging messages. It is supported by a wide variety of devices and receivers across multiple platforms.

1-5.1 Configuration

This section describes how to configure the system log and provide a wide variety of devices and receivers across multiple platforms.

Web Interface

To configure Syslog configuration in the web interface:

1. Click SYSTEM, Syslog.
2. Specify the syslog parameters includes IP Address of Syslog server and Port number.
3. Evoke the Sylog to enable it.
4. Click Save.

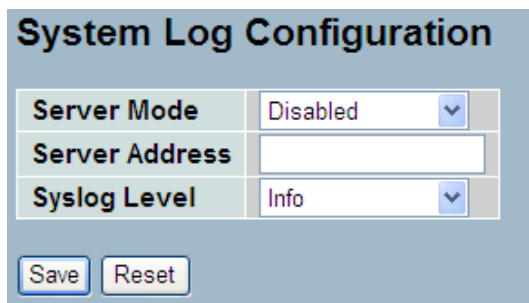

System Log Configuration	
Server Mode	Disabled
Server Address	
Syslog Level	Info

Save Reset

Parameter description:

Server Mode

Indicates the server mode operation. When the mode operation is enabled, the syslog message will send out to syslog server. The syslog protocol is based on UDP communication and received on UDP port 514 and the syslog server will not send acknowledgments back sender since UDP is a connectionless protocol and it does not provide acknowledgments. The syslog packet will always send out even if the syslog server does not exist. Possible modes are:

- Enabled: Enable server mode operation.
- Disabled: Disable server mode operation.

Server Address

Indicates the IPv4 host address of syslog server. If the switch provide DNS feature, it also can be a host name.

Syslog Level

Indicates what kind of message will send to syslog server. Possible modes are:

Emerg: send Emerg

Alert: send Emerg, Alert

Crit: send Emerg, Alert, Crit

Error: send Emerg, Alert, Crit, Error

Warning: Send warnings

Notice: send Emerg, Alert, Crit, Error, Warning, Notice

Info: send Emerg, Alert, Crit, Error, Warning, Notice, Info

Debug : send everything, i.e. all

1-5.2 Log

This section describes that display the system log information of the switch

Web Interface

To display the log configuration in the web interface:

1. Click Syslog, Log.
2. Display the log information.

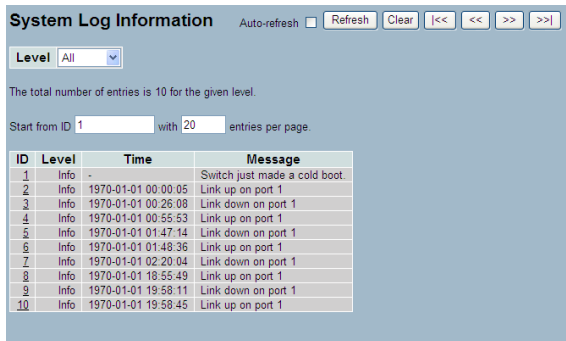

System Log Information Auto-refresh Refresh Clear << << >> >>

Level: All

The total number of entries is 10 for the given level.

Start from ID 1 with 20 entries per page.

ID	Level	Time	Message
1	Info	-	Switch just made a cold boot.
2	Info	1970-01-01 00:00:05	Link up on port 1
3	Info	1970-01-01 00:26:08	Link down on port 1
4	Info	1970-01-01 00:55:53	Link up on port 1
5	Info	1970-01-01 01:47:14	Link down on port 1
6	Info	1970-01-01 01:48:36	Link up on port 1
7	Info	1970-01-01 02:29:04	Link down on port 1
8	Info	1970-01-01 18:55:49	Link up on port 1
9	Info	1970-01-01 19:58:11	Link down on port 1
10	Info	1970-01-01 19:58:45	Link up on port 1

Parameter description:

ID

ID (≥ 1) of the system log entry.

Level

level of the system log entry. The following level types are supported:
Information level of the system log.
Warning: Warning level of the system log.
Error: Error level of the system log.
All: All levels.

Time

The time of the system log entry.

Message

The message of the system log entry.

1-5.3 Detailed Log

This section describes that display the detailed log information of the switch

Web Interface

To display the detailed log configuration in the web interface:

1. Click Syslog, Detailed Log.
2. Display the log information.

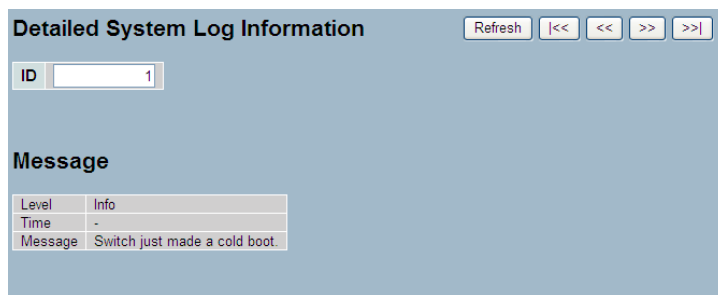

Parameter description:

ID

The ID (≥ 1) of the system log entry.

Message

The detailed message of the system log entry.

1-6 SNMP

Any Network Management System (NMS) running the Simple Network Management Protocol (SNMP) can manage the Managed devices equipped with SNMP agent, provided that the Management Information Base (MIB) is installed correctly on the managed devices. The SNMP is a protocol that is used to govern the transfer of information between SNMP manager and agent and traverses the Object Identity (OID) of the management Information Base (MIB), described in the form of SMI syntax. SNMP agent is running on the switch to response the request issued by SNMP manager.

Basically, it is passive except issuing the trap information. The switch supports a switch to turn on or off the SNMP agent. If you set the field SNMP "Enable", SNMP agent will be started up. All supported MIB OIDs, including RMON MIB, can be accessed via SNMP manager. If the field SNMP is set "Disable", SNMP agent will be de-activated, the related Community Name, Trap Host IP Address, Trap and all MIB counters will be ignored.

1-6.1 System

This section describes how to configure SNMP System on the switch. This function is used to configure SNMP settings, community name, trap host and public traps as well as the throttle of SNMP. A SNMP manager must pass the authentication by identifying both community names, then it can access the MIB information of the target device. So, both parties must have the same community name. Once completing the setting, click <Apply> button, the setting takes effect.

Web Interface

To display the configure SNMP System in the web interface:

1. Click SNMP, System.
2. Evoke SNMP State to enable or disable the SNMP function .
3. Specify the Engine ID
4. Click Apply.

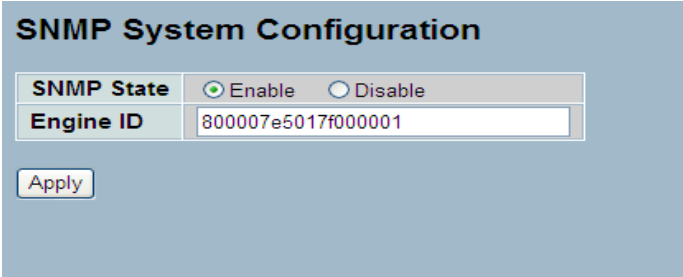

SNMP System Configuration	
SNMP State	<input checked="" type="radio"/> Enable <input type="radio"/> Disable
Engine ID	<input type="text" value="800007e5017f000001"/>
<input type="button" value="Apply"/>	

Parameter description:

These parameters are displayed on the SNMP System Configuration page:]
SNMP State -The term SNMP here The term SNMP here is used for the activation or de-activation of SNMP.

Enable: Enable SNMP state operation.

Disable: Disable SNMP state operation.

Default: Enable.

Engine ID - SNMPv3 engine ID. syntax: 0-9,a-f,A-F, min 5 octet, max 32 octet, fifth octet can't input 00. IF change the Engine ID that will clear all original user.

1-6.2 Communities

The function is used to configure SNMPv3 communities. The Community and UserName is unique. To create a new community account, please check <Add new community> button, and enter the account information then check <Save>. Max Group Number : 4.

Web Interface

To display the configure SNMP Communities in the web interface:

1. Click SNMP, Communities.
2. Click Add new community.
3. Specify the SNMP communities parameters.
4. Click Save.
5. If you want to modify or clear the setting then click Reset.

Delete	Community	UserName	Source IP	Source Mask
<input type="checkbox"/>	public		0.0.0.0	0.0.0.0
<input type="checkbox"/>	private		0.0.0.0	0.0.0.0

Delete	Community	User Name	Source IP
<input type="button" value="Delete"/>			0.0.0.0

Parameter description:

Delete

Check to delete the entry. It will be deleted during the next save.

Community

Indicates the community access string to permit access to SNMPv3 agent. The allowed string length is 1 to 32, and the allowed content is ASCII characters from 33 to 126. The community string will be treated as security name and map a SNMPv1 or SNMPv2c community string.

Source IP

Indicates the SNMP access source address. A particular range of source addresses can be used to restrict source subnet when combined with source mask.

Source Mask

Indicates the SNMP access source address mask

1-6.3 Users

The function is used to configure SNMPv3 user. The Entry index key is UserName. To create a new UserName account, please check <Add new user> button, and enter the user information then check <Save>. Max Group Number : 10.

Web Interface

To display the configure SNMP Users in the web interface:

1. Click SNMP, Users.
2. Specify the Privilege parameter.
3. Click Save.

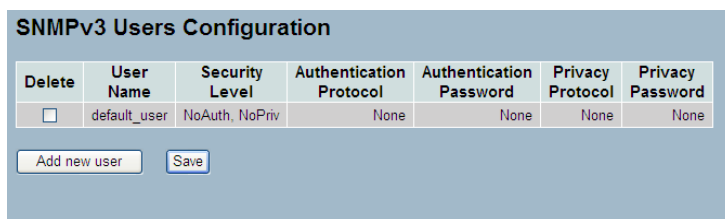

Delete	User Name	Security Level	Authentication Protocol	Authentication Password	Privacy Protocol	Privacy Password
<input type="checkbox"/>	default_user	NoAuth, NoPriv	None	None	None	None

Parameter description:

Delete

Check to delete the entry. It will be deleted during the next save.

Engine ID

An octet string identifying the engine ID that this entry should belong to. The string must contain an even number (in hexadecimal format) with number of digits between 10 and 64, but all-zeros and all-'F's are not allowed. The SNMPv3 architecture uses the User-based Security Model (USM) for message security and the View-based Access Control Model (VACM) for access control. For the USM entry, the usmUserEngineID and Usm User Name are the entry's keys. In a simple agent, usmUserEngineID is always that agent's own snmpEngineID value. The value can also take the value of the snmpEngineID of a remote SNMP engine with which this user can communicate. In other words, if user engine ID equal system engine ID then it is local user; otherwise it's remote user.

User Name

A string identifying the user name that this entry should belong to. The allowed string length is 1 to 32, and the allowed content is ASCII characters from 33 to 126.

Security Level

Indicates the security model that this entry should belong to. Possible security models are:

NoAuth, NoPriv: No authentication and no privacy.

Auth, NoPriv: Authentication and no privacy.

Auth, Priv: Authentication and privacy.

The value of security level cannot be modified if entry already exists. That means it must first be ensured that the value is set correctly.

Authentication Protocol

Indicates the authentication protocol that this entry should belong to.

Possible authentication protocols are:

None: No authentication protocol.

MD5: An optional flag to indicate that this user uses MD5 authentication protocol.

SHA: An optional flag to indicate that this user uses SHA authentication protocol.

The value of security level cannot be modified if entry already exists. That means must first ensure that the value is set correctly.

Authentication Password

A string identifying the authentication password phrase. For MD5 authentication protocol, the allowed string length is 8 to 32. For SHA authentication protocol, the allowed string length is 8 to 40. The allowed content is ASCII characters from 33 to 126.

Privacy Protocol

Indicates the privacy protocol that this entry should belong to. Possible privacy protocols are:

None: No privacy protocol.

DES: An optional flag to indicate that this user uses DES authentication protocol.

Privacy Password

A string identifying the privacy password phrase. The allowed string length is 8 to 32, and the allowed content is ASCII characters from 33 to 126.

1-6.4 Groups

The function is used to configure SNMPv3 group. The Entry index key are Security Model and Security Name. To create a new group account, please check <Add new group> button, and enter the group information then check <Save>. Max Group Number : v1: 2, v2: 2, v3:10.

Web Interface

To display the configure SNMP Groups in the web interface:

1. Click SNMP, Groups.
2. Specify the Privilege parameter.
3. Click Save.

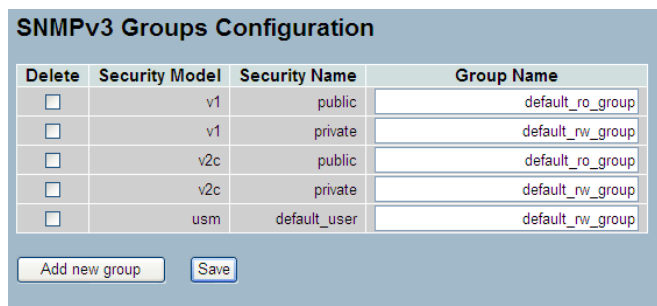

Delete	Security Model	Security Name	Group Name
<input type="checkbox"/>	v1	public	default_ro_group
<input type="checkbox"/>	v1	private	default_rw_group
<input type="checkbox"/>	v2c	public	default_ro_group
<input type="checkbox"/>	v2c	private	default_rw_group
<input type="checkbox"/>	usm	default_user	default_rw_group

Parameter description:

Delete

Check to delete the entry. It will be deleted during the next save.

Security Model

Indicates the security model that this entry should belong to. Possible security models are:

v1: Reserved for SNMPv1.

v2c: Reserved for SNMPv2c.

usm: User-based Security Model (USM).

Security Name

A string identifying the security name that this entry should belong to. The allowed string length is 1 to 32, and the allowed content is ASCII characters from 33 to 126.

Group Name

A string identifying the group name that this entry should belong to. The allowed string length is 1 to 32, and the allowed content is ASCII characters from 33 to 126.

1-6.5 Views

The function is used to configure SNMPv3 view. The Entry index key are OID Subtree and View Name. To create a new view account, please check <Add new view> button, and enter the view information then check <Save>. Max Group Number : 28.

Configure SNMPv3 view table on this page. The entry index keys are View Name and OID Subtree.

Web Interface

1. Click SNMP, Views.
2. Click Add new View.
3. Specify the SNMP View parameters.
4. Click Save.
5. If you want to modify or clear the setting then click Reset.

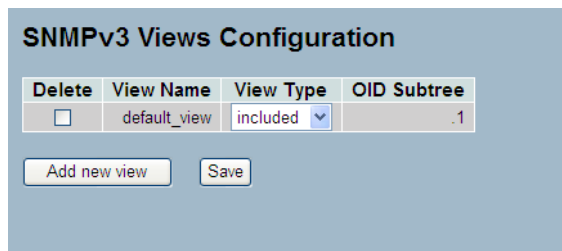

Delete	View Name	View Type	OID Subtree
<input type="checkbox"/>	default_view	included	.1

Parameter description:

Delete

Check to delete the entry. It will be deleted during the next save.

View Name

A string identifying the view name that this entry should belong to. The allowed string length is 1 to 32, and the allowed content is ASCII characters from 33 to 126.

View Type

Indicates the view type that this entry should belong to. Possible view types are:

included: An optional flag to indicate that this view subtree should be included.

excluded: An optional flag to indicate that this view subtree should be excluded.

In general, if a view entry's view type is 'excluded', there should be another view entry existing with view type as 'included' and it's OID subtree should overstep the 'excluded' view entry.

OID Subtree

The OID defining the root of the subtree to add to the named view. The allowed OID length is 1 to 128. The allowed string content is digital number or asterisk(*).

1-6.6 Access

The function is used to configure SNMPv3 accesses. The Entry index key are Group Name, Security Model and Security level. To create a new access account, please check <Add new access> button, and enter the access information then check <Save>. Max Group Number : 14

Web Interface

To display the configure SNMP Access in the web interface:

1. Click SNMP, Accesses.
2. Click Add new Access.
3. Specify the SNMP Access parameters.
4. Click Save.
5. If you want to modify or clear the setting then click Reset.

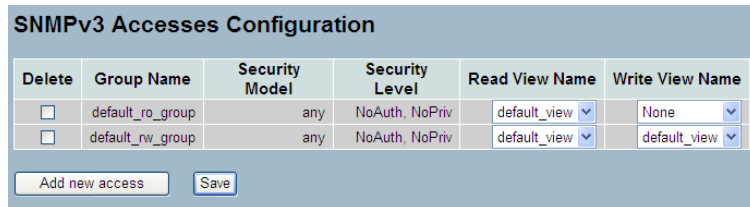

Delete	Group Name	Security Model	Security Level	Read View Name	Write View Name
<input type="checkbox"/>	default_ro_group	any	NoAuth, NoPriv	default_view	None
<input type="checkbox"/>	default_rw_group	any	NoAuth, NoPriv	default_view	default_view

Parameter description:

Delete

Check to delete the entry. It will be deleted during the next save.

Group Name

A string identifying the group name that this entry should belong to. The allowed string length is 1 to 32, and the allowed content is ASCII characters from 33 to 126.

Security Model

Indicates the security model that this entry should belong to. Possible security models are:

any: Any security model accepted(v1|v2c|usm).

v1: Reserved for SNMPv1.

v2c: Reserved for SNMPv2c.

usm: User-based Security Model (USM).

Security Level

Indicates the security model that this entry should belong to. Possible security models are:

NoAuth, NoPriv: No authentication and no privacy.

Auth, NoPriv: Authentication and no privacy.

Auth, Priv: Authentication and privacy.

Read View Name

The name of the MIB view defining the MIB objects for which this request may request the current values. The allowed string length is 1 to 32, and the allowed content is ASCII characters from 33 to 126. Write View Name

The name of the MIB view defining the MIB objects for which this request may potentially set new values. The allowed string length is 1 to 32, and the allowed content is ASCII characters from 33 to 126.

1-6.7 Tarp

The function is used to configure SNMP trap. To create a new trap account, please check <No number> button, and enter the trap information then check <Apply>. Max Group Number : 6.

Web Interface

To configure SNMP Trap setting:

1. Click SNMP, Trap .
2. Display the SNMP Trap Hosts information table.
3. Choice a entry to display and modify the detail parameters or click delete button to delete the trap hosts entry.

Trap Hosts Configuration

Delete	No	Version	Server IP	UDP Port	Community/Security Name	Severity Level	Security Level	Authentication Protocol	Privacy Protocol
	1								
	2								
	3								
	4								
	5								
	6								

Trap Host Configuration

Trap Version	v2c
Server IP	0.0.0.0
UDP Port	162
Community/Security Name	
Severity Level	Info
Security Level	NoAuth, NoPriv
Authentication Protocol	MD5
Authentication Password	
Privacy Protocol	DES
Privacy Password	

Parameters description:

Delete:

Check <Delete> entry then check <Save> button, the entry will be delete.

Trap Version:

You may choose v1, v2c or v3 trap.

Server IP:

SNMP Host IP address.

UDP Port:

Port number. Default: 162

Community / Security Name:

The length of "Community / Security Name" string is restricted to 1-32.

Security Level:

Indicates what kind of message will send to Security Level.

Possible modes are:

Info: Send informations, warnings and errors.

Warning: Send warnings and errors.

Error: Send errors.

Security Level:

There are three kinds of choices.

NoAuth, NoPriv: No authentication and no privacy.

Auth, NoPriv: Authentication and no privacy.

Auth, Priv: Authentication and privacy.

Authentication Protocol:

You can choose MD5 or SHA for authentication.

Authentication Password:

The length of 'MD5 Authentication Password' is restricted to 8 – 32.

The length of 'SHA Authentication Password' is restricted to 8 – 40.

Privacy Protocol:

You can set DES encryption for UserName.

Privacy Password:

The length of ' Privacy Password ' is restricted to 8 – 32.

2. Configuration

This chapter describes all of the basic network configuration tasks which includes the Ports, Layer 2 network protocol (e.g. VLANs, QoS, IGMP, ACLs etc.) and any setting of the Switch.

2-1 Port

The section describes to configure the Port detail parameters of the switch. Others you could using the Port configure to enable or disable the Port of the switch. Monitor the ports content or status in the function.

2-1.1 Configuration

This chapter describes how to view the current port configuration and how to configure ports to non-default settings, including

Linkup/Linkdown

Speed (Current and configured)

Flow Control (Current Rx, Current Tx and Configured)

Maximum Frame Size

Excessive Collision Mode

Power Control.

Web Interface

To configure an Current Port Configuration in the web interface:

1. Click Configuration, Port, then Configuration
2. Specify the Speed Configured, Flow Control , Maximum Frame size , Excessive Collision mode and Power Control.
3. Click Save.

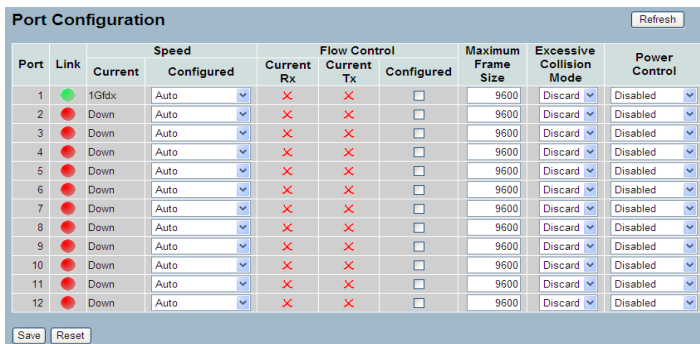

The screenshot shows a web interface titled "Port Configuration" with a "Refresh" button in the top right corner. Below the title is a table with columns for Port, Link, Speed (Current, Configured), Flow Control (Current Rx, Current Tx, Configured), Maximum Frame Size, Excessive Collision Mode, and Power Control. The table lists 12 ports. Port 1 is the only one with a green link status and "1Gfdx" speed. All other ports (2-12) have a red link status and "Down" link. All "Configured" cells in the Speed and Flow Control columns are empty checkboxes. All "Maximum Frame Size", "Excessive Collision Mode", and "Power Control" cells contain dropdown menus with "9600", "Discard", and "Disabled" respectively.

Port	Link	Speed		Flow Control			Maximum Frame Size	Excessive Collision Mode	Power Control
		Current	Configured	Current Rx	Current Tx	Configured			
1	● 1Gfdx	Auto	Auto	×	×	<input type="checkbox"/>	9600	Discard	Disabled
2	● Down	Auto	Auto	×	×	<input type="checkbox"/>	9600	Discard	Disabled
3	● Down	Auto	Auto	×	×	<input type="checkbox"/>	9600	Discard	Disabled
4	● Down	Auto	Auto	×	×	<input type="checkbox"/>	9600	Discard	Disabled
5	● Down	Auto	Auto	×	×	<input type="checkbox"/>	9600	Discard	Disabled
6	● Down	Auto	Auto	×	×	<input type="checkbox"/>	9600	Discard	Disabled
7	● Down	Auto	Auto	×	×	<input type="checkbox"/>	9600	Discard	Disabled
8	● Down	Auto	Auto	×	×	<input type="checkbox"/>	9600	Discard	Disabled
9	● Down	Auto	Auto	×	×	<input type="checkbox"/>	9600	Discard	Disabled
10	● Down	Auto	Auto	×	×	<input type="checkbox"/>	9600	Discard	Disabled
11	● Down	Auto	Auto	×	×	<input type="checkbox"/>	9600	Discard	Disabled
12	● Down	Auto	Auto	×	×	<input type="checkbox"/>	9600	Discard	Disabled

At the bottom of the interface are "Save" and "Reset" buttons.

Parameter description:

Port

This is the logical port number for this row.

Link

The current link state is displayed graphically. Green indicates the link is up and red that it is down.

Current Link Speed

Provides the current link speed of the port.

Configured Link Speed

Select any available link speed for the given switch port.

Auto Speed selects the highest speed that is compatible with a link partner.

Disabled disables the switch port operation.

Flow Control

When Auto Speed is selected on a port, this section indicates the flow control capability that is advertised to the link partner. When a fixed-speed setting is selected, that is what is used. The Current Rx column indicates whether pause frames on the port are obeyed, and the Current Tx column indicates whether pause frames on the port are transmitted. The Rx and Tx settings are determined by the result of the last Auto-Negotiation. Check the configured column to use flow control. This setting is related to the setting for Configured Link Speed.

Maximum Frame Size

Enter the maximum frame size allowed for the switch port, including FCS.

Excessive Collision Mode

Configure port transmit collision behavior.

Discard: Discard frame after 16 collisions (default).

Restart: Restart backoff algorithm after 16 collisions.

Power Control

The Usage column shows the current percentage of the power consumption per port. The Configured column allows for changing the power savings mode parameters per port.

Disabled: All power savings mechanisms disabled.

ActiPHY: Link down power savings enabled.

PerfectReach: Link up power savings enabled.

Enabled: Both link up and link down power savings enabled.

2-1.2 Port Description

The section describes to configure the Port's alias or any descriptions for the Port Identity. It provides user to write down an alphanumeric string describing the full name and version identification for the system's hardware type, software version, and networking application

Web Interface

To configure an Port Description in the web interface:

1. Click Configuration, Port, then Port Description
2. Specify the detail Port alias or description an alphanumeric string describing the full name and version identification for the system's hardware type, software version, and networking application.
3. Click Save.

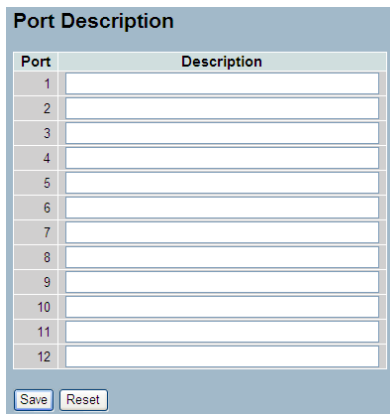

Port	Description
1	<input type="text"/>
2	<input type="text"/>
3	<input type="text"/>
4	<input type="text"/>
5	<input type="text"/>
6	<input type="text"/>
7	<input type="text"/>
8	<input type="text"/>
9	<input type="text"/>
10	<input type="text"/>
11	<input type="text"/>
12	<input type="text"/>

2-1.3 Traffic Overview

The section describes to the Port statistics information and provides overview of general traffic statistics for all switch ports. The ports belong to the currently selected stack unit, as reflected by the page header

Web Interface

To Display the Port Statistics Overview in the web interface:

1. Click Configuration, Port, then Traffic Overview
2. If you want to auto-refresh then you need to evoke the “Auto-refresh” .
3. Click “ Refresh“ to refresh the port statistics or clear all information when you click “ Clear”.

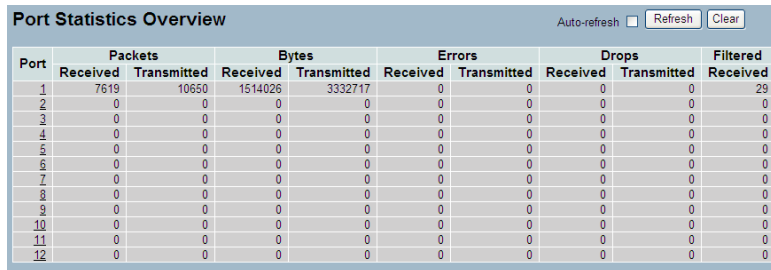

The screenshot shows a web interface titled "Port Statistics Overview" with a table of statistics for ports 1 through 12. The table has columns for Port, Packets (Received, Transmitted), Bytes (Received, Transmitted), Errors (Received, Transmitted), Drops (Received, Transmitted), and Filtered Received. Port 1 shows non-zero values for Packets Received (7619), Packets Transmitted (10650), Bytes Received (1514026), and Bytes Transmitted (3332717). All other ports show zero values. The interface also includes an "Auto-refresh" checkbox, a "Refresh" button, and a "Clear" button.

Port	Packets		Bytes		Errors		Drops		Filtered Received
	Received	Transmitted	Received	Transmitted	Received	Transmitted	Received	Transmitted	
1	7619	10650	1514026	3332717	0	0	0	0	29
2	0	0	0	0	0	0	0	0	0
3	0	0	0	0	0	0	0	0	0
4	0	0	0	0	0	0	0	0	0
5	0	0	0	0	0	0	0	0	0
6	0	0	0	0	0	0	0	0	0
7	0	0	0	0	0	0	0	0	0
8	0	0	0	0	0	0	0	0	0
9	0	0	0	0	0	0	0	0	0
10	0	0	0	0	0	0	0	0	0
11	0	0	0	0	0	0	0	0	0
12	0	0	0	0	0	0	0	0	0

Parameter description:

Port

The logical port for the settings contained in the same row.

Packets

The number of received and transmitted packets per port.

Bytes

The number of received and transmitted bytes per port.

Errors

The number of frames received in error and the number of incomplete transmissions per port.

Drops

The number of frames discarded due to ingress or egress congestion.

Filtered

The number of received frames filtered by the forwarding

2-1.4 Detailed Statistics

The section describes how to provide detailed traffic statistics for a specific switch port. Use the port select box to select which switch port details to display. The selected port belongs to the currently selected stack unit, as reflected by the page header.

The displayed counters are the totals for receive and transmit, the size counters for receive and transmit, and the error counters for receive and transmit.

Web Interface

To Display the per Port detailed Statistics Overview in the web interface:

1. Click Configuration, Port, then Detailed Port Statistics
2. Scroll the Port Index to select which port you want to show the detailed Port statistics overview” .
3. If you want to auto-refresh the information then you need to evoke the “Auto-refresh”.
4. Click “ Refresh” to refresh the port detailed statistics or clear all information when you click “ Clear”.

Receive Total		Transmit Total	
Rx Packets	7637	Tx Packets	10688
Rx Octets	1518566	Tx Octets	3337459
Rx Unicast	7163	Tx Unicast	4574
Rx Multicast	29	Tx Multicast	5714
Rx Broadcast	425	Tx Broadcast	0
Rx Pause	0	Tx Pause	0
Receive Size Counters		Transmit Size Counters	
Rx 64 Bytes	4761	Tx 64 Bytes	72
Rx 65-127 Bytes	200	Tx 65-127 Bytes	5380
Rx 128-255 Bytes	86	Tx 128-255 Bytes	2866
Rx 256-511 Bytes	2588	Tx 256-511 Bytes	97
Rx 512-1023 Bytes	2	Tx 512-1023 Bytes	2139
Rx 1024-1526 Bytes	0	Tx 1024-1526 Bytes	154
Rx 1527+ Bytes	0	Tx 1527+ Bytes	0
Receive Queue Counters		Transmit Queue Counters	
Rx Q0	7637	Tx Q0	0
Rx Q1	0	Tx Q1	0
Rx Q2	0	Tx Q2	0
Rx Q3	0	Tx Q3	0
Rx Q4	0	Tx Q4	0
Rx Q5	0	Tx Q5	0
Rx Q6	0	Tx Q6	0
Rx Q7	0	Tx Q7	10688

Parameter description:

Receive Total and Transmit Total

Rx and Tx Packets

The number of received and transmitted (good and bad) packets.

Rx and Tx Octets

The number of received and transmitted (good and bad) bytes. Includes FCS, but excludes framing bits.

Rx and Tx Unicast

The number of received and transmitted (good and bad) unicast packets.

Rx and Tx Multicast

The number of received and transmitted (good and bad) multicast packets.

Rx and Tx Broadcast

The number of received and transmitted (good and bad) broadcast packets.

Rx and Tx Pause

A count of the MAC Control frames received or transmitted on this port that have an opcode indicating a PAUSE operation.

Receive and Transmit Size Counters

The number of received and transmitted (good and bad) packets split into categories based on their respective frame sizes.

Receive and Transmit Queue Counters

The number of received and transmitted packets per input and output queue.

Receive Error Counters

Rx Drops

The number of frames dropped due to lack of receive buffers or egress congestion.

Rx CRC/Alignment

The number of frames received with CRC or alignment errors.

Rx Undersize

The number of short 1 frames received with valid CRC.

Rx Oversize

The number of long 2 frames received with valid CRC.

Rx Fragments

The number of short 1 frames received with invalid CRC.

Rx Jabber

The number of long 2 frames received with invalid CRC.

Rx Filtered

The number of received frames filtered by the forwarding process.

Short frames are frames that are smaller than 64 bytes.

Long frames are frames that are longer than the configured maximum frame length for this port.

Transmit Error Counters

Tx Drops

The number of frames dropped due to output buffer congestion.

Tx Late/Exc. Coll.

The number of frames dropped due to excessive or late collisions.

2-1.5 Qos Statistics

The section describes that switch could display the QoS detailed Queuing counters for a specific switch port. for the different queues for all switch ports. The ports belong to the currently selected stack unit, as reflected by the page header.

Web Interface

To Display the Queuing Counters in the web interface:

1. Click Configuration, Port, then QoS Statistics
2. If you want to auto-refresh the information then you need to evoke the "Auto-refresh".
3. Click " Refresh" to refresh the Queuing Counters or clear all information when you click " Clear".

Port	Q0		Q1		Q2		Q3		Q4		Q5		Q6		Q7		
	Rx	Tx	Rx	Tx	Rx	Tx	Rx	Tx	Rx	Tx	Rx	Tx	Rx	Tx	Rx	Tx	
1	7665	0	0	0	0	0	0	0	0	0	0	0	0	0	0	0	10732
2	0	0	0	0	0	0	0	0	0	0	0	0	0	0	0	0	0
3	0	0	0	0	0	0	0	0	0	0	0	0	0	0	0	0	0
4	0	0	0	0	0	0	0	0	0	0	0	0	0	0	0	0	0
5	0	0	0	0	0	0	0	0	0	0	0	0	0	0	0	0	0
6	0	0	0	0	0	0	0	0	0	0	0	0	0	0	0	0	0
7	0	0	0	0	0	0	0	0	0	0	0	0	0	0	0	0	0
8	0	0	0	0	0	0	0	0	0	0	0	0	0	0	0	0	0
9	0	0	0	0	0	0	0	0	0	0	0	0	0	0	0	0	0
10	0	0	0	0	0	0	0	0	0	0	0	0	0	0	0	0	0
11	0	0	0	0	0	0	0	0	0	0	0	0	0	0	0	0	0
12	0	0	0	0	0	0	0	0	0	0	0	0	0	0	0	0	0

Parameter description:

Port

The logical port for the settings contained in the same row.

Low Queue

There are 4 QoS queues per port with strict or weighted queue scheduling. This is the lowest priority queue.

Normal Queue

This is the normal priority queue of the 4 QoS queues. It has higher priority than the "Low Queue".

Medium Queue

This is the medium priority queue of the 4 QoS queues. It has higher priority than the "Normal Queue".

High Queue

This is the highest priority queue of the 4 QoS queues.

Received/Transmitted

The number of received and transmitted packets per queue.

Port

The logical port for the settings contained in the same row.

Qn

There are ? QoS queues per port. Q0 is the lowest priority queue.

Rx/Tx

The number of received and transmitted packets per queue.

2-1.6 SFP Information

The section describes that switch could display the SFP module detail information which you connect it to the switch. The information includes: Connector type, Fiber type, wavelength, baud rate and Vendor OUI etc.

Web Interface

To Display the SFP information in the web interface:

1. Click Configuration, Port, then SFP Information
2. To display the SFP Information.

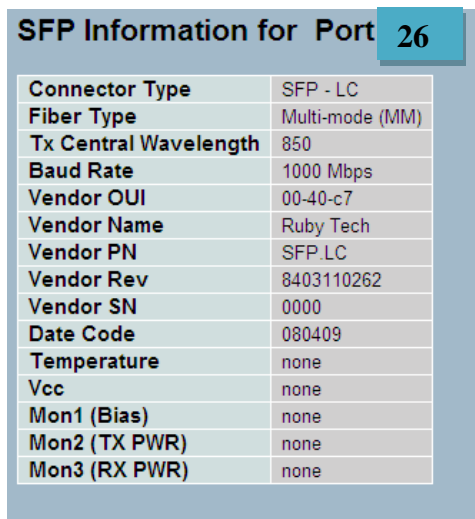

The image shows a screenshot of a web interface displaying SFP information for Port 26. The title is "SFP Information for Port 26". Below the title is a table with 15 rows and 2 columns. The first column contains parameter names, and the second column contains their values.

Parameter	Value
Connector Type	SFP - LC
Fiber Type	Multi-mode (MM)
Tx Central Wavelength	850
Baud Rate	1000 Mbps
Vendor OUI	00-40-c7
Vendor Name	Ruby Tech
Vendor PN	SFP.LC
Vendor Rev	8403110262
Vendor SN	0000
Date Code	080409
Temperature	none
Vcc	none
Mon1 (Bias)	none
Mon2 (TX PWR)	none
Mon3 (RX PWR)	none

Parameter description:

Connector Type:

Display the connector type, for instance, UTP, SC, ST, LC and so on.

Fiber Type:

Display the fiber mode, for instance, Multi-Mode, Single-Mode.

Tx Central Wavelength:

Display the fiber optical transmitting central wavelength, for instance, 850nm, 1310nm, 1550nm and so on.

Baud Rate:

Display the maximum baud rate of the fiber module supported, for instance, 10M, 100M, 1G and so on.

Vendor OUI:

Display the Manufacturer's OUI code which is assigned by IEEE.

Vendor Name:

Display the company name of the module manufacturer.

Vendor P/N:

Display the product name of the naming by module manufacturer.

Vendor Rev (Revision):

Display the module revision.

Vendor SN (Serial Number):

Show the serial number assigned by the manufacturer.

Date Code:

Show the date this SFP module was made.

Temperature:

Show the current temperature of SFP module.

Vcc:

Show the working DC voltage of SFP module.

Mon1(Bias) mA:

Show the Bias current of SFP module.

Mon2(TX PWR):

Show the transmit power of SFP module.

Mon3(RX PWR):

Show the receiver power of SFP module.

2-1.7 EEE

The section which allows the user to inspect and configure the current EEE port settings.

EEE is a power saving option that reduces the power usage when there is very low traffic utilization (or no traffic).

EEE works by powering down circuits when there is no traffic. When a port gets data to be transmitted all circuits are powered up. The time it takes to power up the circuits is named wakeup time. The default wakeup time is 17 us for 1Gbit links and 30 us for other link speeds. EEE devices must agree upon the value of the wakeup time in order to make sure that both the receiving and transmitting device has all circuits powered up when traffic is transmitted. The devices can exchange information about the devices wakeup time using the LLDP protocol.

For maximizing the power saving, the circuit isn't started at once transmit data are ready for a port, but is instead queued until 3000 bytes of data are ready to be transmitted. For not introducing a large delay in case that data less then 3000 bytes shall be transmitted, data are always transmitted after 48 us, giving a maximum latency of 48 us + the wakeup time.

If desired it is possible to minimize the latency for specific frames, by mapping the frames to a specific queue (done with QOS), and then mark the queue as an urgent queue. When an urgent queue gets data to be transmitted, the circuits will be powered up at once and the latency will be reduced to the wakeup time.

Web Interface

To configure the EEE Configuration in the web interface:

1. Click Configuration, Port, then EEE
2. To evoke which port wants to enable the EEE function. To evoke which
3. EEE Urgent Queues level and the range from 1 to 8. the queue will postpone the transmission until 3000 bytes are ready to be transmitted.
4. Click the save to save the setting
5. If you want to cancel the setting then you need to click the reset button. It will revert to previously saved values.

EEE Configuration

Port	EEE Enabled	EEE Urgent Queues							
		1	2	3	4	5	6	7	8
1	<input type="checkbox"/>	<input type="checkbox"/>	<input type="checkbox"/>	<input type="checkbox"/>	<input type="checkbox"/>	<input type="checkbox"/>	<input type="checkbox"/>	<input type="checkbox"/>	<input type="checkbox"/>
2	<input type="checkbox"/>	<input type="checkbox"/>	<input type="checkbox"/>	<input type="checkbox"/>	<input type="checkbox"/>	<input type="checkbox"/>	<input type="checkbox"/>	<input type="checkbox"/>	<input type="checkbox"/>
3	<input type="checkbox"/>	<input type="checkbox"/>	<input type="checkbox"/>	<input type="checkbox"/>	<input type="checkbox"/>	<input type="checkbox"/>	<input type="checkbox"/>	<input type="checkbox"/>	<input type="checkbox"/>
4	<input type="checkbox"/>	<input type="checkbox"/>	<input type="checkbox"/>	<input type="checkbox"/>	<input type="checkbox"/>	<input type="checkbox"/>	<input type="checkbox"/>	<input type="checkbox"/>	<input type="checkbox"/>
5	<input type="checkbox"/>	<input type="checkbox"/>	<input type="checkbox"/>	<input type="checkbox"/>	<input type="checkbox"/>	<input type="checkbox"/>	<input type="checkbox"/>	<input type="checkbox"/>	<input type="checkbox"/>
6	<input type="checkbox"/>	<input type="checkbox"/>	<input type="checkbox"/>	<input type="checkbox"/>	<input type="checkbox"/>	<input type="checkbox"/>	<input type="checkbox"/>	<input type="checkbox"/>	<input type="checkbox"/>
7	<input type="checkbox"/>	<input type="checkbox"/>	<input type="checkbox"/>	<input type="checkbox"/>	<input type="checkbox"/>	<input type="checkbox"/>	<input type="checkbox"/>	<input type="checkbox"/>	<input type="checkbox"/>
8	<input type="checkbox"/>	<input type="checkbox"/>	<input type="checkbox"/>	<input type="checkbox"/>	<input type="checkbox"/>	<input type="checkbox"/>	<input type="checkbox"/>	<input type="checkbox"/>	<input type="checkbox"/>
9	<input type="checkbox"/>	<input type="checkbox"/>	<input type="checkbox"/>	<input type="checkbox"/>	<input type="checkbox"/>	<input type="checkbox"/>	<input type="checkbox"/>	<input type="checkbox"/>	<input type="checkbox"/>
10	<input type="checkbox"/>	<input type="checkbox"/>	<input type="checkbox"/>	<input type="checkbox"/>	<input type="checkbox"/>	<input type="checkbox"/>	<input type="checkbox"/>	<input type="checkbox"/>	<input type="checkbox"/>

Save

Reset

Parameter description:

EEE Port Configuration

The EEE port settings relate to the currently selected stack unit, as reflected by the page header.

Port

The switch port number of the logical EEE port.

EEE Enabled

Controls whether EEE is enabled for this switch port.

EEE Urgent Queues

Queues set will activate transmission of frames as soon as any data is available. Otherwise the queue will postpone the transmission until 3000 bytes are ready to be transmitted.

2-2 ACL

The LGS-2624C-DNV switch access control list (ACL) is probably the most commonly used object in the IOS. It is used for packet filtering but also for selecting types of traffic to be analyzed, forwarded, or influenced in some way. The ACLs are divided into EtherTypes, IPv4, ARP protocol, MAC and VLAN parameters etc. Here we will just go over the standard and extended access lists for TCP/IP. As you create ACEs for ingress classification, you can assign a policy for each port, the policy number is 1-8, however, each policy can be applied to any port. This makes it very easy to determine what type of ACL policy you will be working with.

2-2.1 Ports

The section describes how to configure the ACL parameters (ACE) of the each switch port. These parameters will affect frames received on a port unless the frame matches a specific ACE

Web Interface

To configure the ACL Ports Configuration in the web interface:

1. Click Configuration, ACL, then Ports
2. To scroll the specific parameter value to select the correct value for port ACL setting.
3. Click the save to save the setting
4. If you want to cancel the setting then you need to click the reset button. It will revert to previously saved values.
5. After you configure complete then you could see the Counter of the port . then you could click refresh to update the counter or Clear the information.

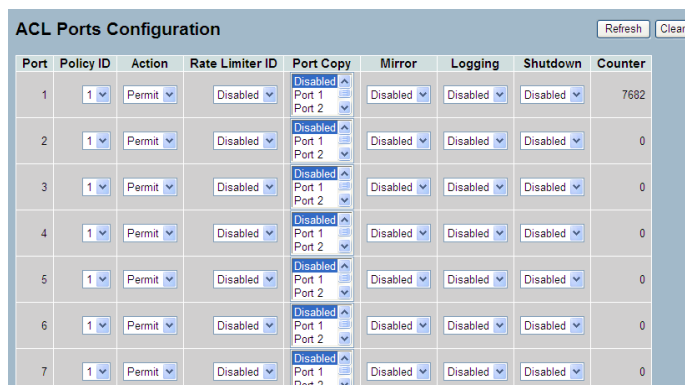

Port	Policy ID	Action	Rate Limiter ID	Port Copy	Mirror	Logging	Shutdown	Counter
1	1	Permit	Disabled	Disabled Port 1 Port 2	Disabled	Disabled	Disabled	7682
2	1	Permit	Disabled	Disabled Port 1 Port 2	Disabled	Disabled	Disabled	0
3	1	Permit	Disabled	Disabled Port 1 Port 2	Disabled	Disabled	Disabled	0
4	1	Permit	Disabled	Disabled Port 1 Port 2	Disabled	Disabled	Disabled	0
5	1	Permit	Disabled	Disabled Port 1 Port 2	Disabled	Disabled	Disabled	0
6	1	Permit	Disabled	Disabled Port 1 Port 2	Disabled	Disabled	Disabled	0
7	1	Permit	Disabled	Disabled Port 1 Port 2	Disabled	Disabled	Disabled	0

Parameter description:

Port

The logical port for the settings contained in the same row.

Policy ID

Select the policy to apply to this port. The allowed values are 1 through 8. The default value is 1.

Action

Select whether forwarding is permitted ("Permit") or denied ("Deny"). The default value is "Permit".

Rate Limiter ID

Select which rate limiter to apply on this port. The allowed values are Disabled or the values 1 through 16. The default value is "Disabled".

Port Copy

Select which port frames are copied on. The allowed values are Disabled or a specific port number. The default value is "Disabled".

Mirror

Specify the mirror operation of this port. The allowed values are:
Enabled: Frames received on the port are mirrored.
Disabled: Frames received on the port are not mirrored.
The default value is "Disabled".

Logging

Specify the logging operation of this port. The allowed values are:
Enabled: Frames received on the port are stored in the System Log.
Disabled: Frames received on the port are not logged.
The default value is "Disabled". Please note that the System Log memory size and logging rate is limited.

Shutdown

Specify the port shut down operation of this port. The allowed values are:
Enabled: If a frame is received on the port, the port will be disabled.
Disabled: Port shut down is disabled.
The default value is "Disabled".

Counter

Counts the number of frames that match this ACE.

2-2.2 Rate Limiters

The section describes how to configure the switch's ACL Rate Limiter parameters. The Rate Limiter Level from 1 to 16 that allow user to set rate limiter value and units with pps or kbps.

Web Interface

To configure ACL Rate Limiter in the web interface:

1. Click Configuration, ACL, then Rate Limiter
2. To specific the Rate field and the range from 0 to 3276700.
3. To scroll the Unit with pps or kbps
- 4 . Click the save to save the setting
5. If you want to cancel the setting then you need to click the reset button.
It will revert to previously saved values.

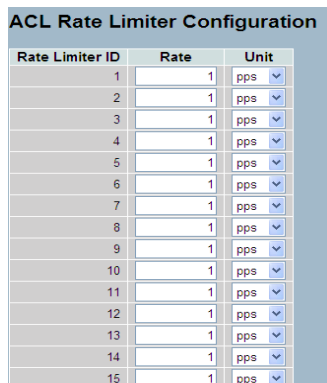

Rate Limiter ID	Rate	Unit
1	1	pps
2	1	pps
3	1	pps
4	1	pps
5	1	pps
6	1	pps
7	1	pps
8	1	pps
9	1	pps
10	1	pps
11	1	pps
12	1	pps
13	1	pps
14	1	pps
15	1	pps

Parameter description:

Rate Limiter ID

The rate limiter ID for the settings contained in the same row.

Rate

The rate unit is packets per second (pps), configure the rate as 1, 2, 4, ..., 512, 1K, 2K, 4K, ..., 3276700k.

The 1 kpps is actually 1002.1 pps.

Rate

The allowed values are: 0-3276700 in pps
or 0, 100, 200, 300, ..., 1000000 in kbps.

Unit

Specify the rate unit. The allowed values are:

pps: packets per second.

kbps: Kbits per second.

2-2.3 Access Control List

The section describes how to configure Access Control List rule. An Access Control List (ACL) is a sequential list of permit or deny conditions that apply to IP addresses, MAC addresses, or other more specific criteria. This switch tests ingress packets against the conditions in an ACL one by one. A packet will be accepted as soon as it matches a permit rule, or dropped as soon as it matches a deny rule. If no rules match, the frame is accepted. Other actions can also be invoked when a matching packet is found, including rate limiting, copying matching packets to another port or to the system log, or shutting down a port.

This page shows the Access Control List (ACL), which is made up of the ACEs defined on this switch. Each row describes the ACE that is defined. The maximum number of ACEs is 256 on each switch. Click on the lowest plus sign to add a new ACE to the list. The reserved ACEs used for internal protocol, cannot be edited or deleted, the order sequence cannot be changed and the priority is highest.

Web Interface

To configure Access Control List in the web interface:

1. Click Configuration, ACL, then Configuration
2. Click the  button to add a new ACL, or use the other ACL modification buttons to specify the editing action (i.e., edit, delete, or moving the relative position of entry in the list)
3. To specify the parameter of the ACE
4. Click the save to save the setting
5. If you want to cancel the setting then you need to click the reset button. It will revert to previously saved values.
6. When editing an entry on the ACE Configuration page, note that the items displayed depend on various selections, such as Frame Type and IP Protocol Type. Specify the relevant criteria to be matched for this rule, and set the actions to take when a rule is matched (such as Rate Limiter, Port Copy, Logging, and Shutdown).



The screenshot shows the 'ACE Configuration' window. On the left, there are three dropdown menus: 'Ingress Port' (set to 'Any'), 'Policy' (with 'Policy 1' and 'Policy 2' visible), and 'Frame Type' (set to 'Any'). On the right, there is a table of settings:

Action	Permit
Rate Limiter	Disabled
Port Copy	Disabled
Mirror	Disabled
Logging	Disabled
Shutdown	Disabled
Counter	0

Below this table is the 'VLAN Parameters' section with three dropdown menus: '802.1Q Tagged' (set to 'Any'), 'VLAN ID Filter' (set to 'Any'), and 'Tag Priority' (set to 'Any'). At the bottom left are 'Save', 'Reset', and 'Cancel' buttons.

Parameter description:

Ingress Port

Indicates the ingress port of the ACE. Possible values are:
 Any: The ACE will match any ingress port.
 Policy: The ACE will match ingress ports with a specific policy.
 Port: The ACE will match a specific ingress port.

Frame Type

Indicates the frame type of the ACE. Possible values are:
 Any: The ACE will match any frame type.
 EType: The ACE will match Ethernet Type frames. Note that an Ethernet Type based ACE will not get matched by IP and ARP frames.
 ARP: The ACE will match ARP/RARP frames.
 IPv4: The ACE will match all IPv4 frames.
 IPv4/ICMP: The ACE will match IPv4 frames with ICMP protocol.
 IPv4/UDP: The ACE will match IPv4 frames with UDP protocol.
 IPv4/TCP: The ACE will match IPv4 frames with TCP protocol.
 IPv4/Other: The ACE will match IPv4 frames, which are not ICMP/UDP/TCP.
 IPv6: The ACE will match all IPv6 standard frames.

Action

Indicates the forwarding action of the ACE.
 Permit: Frames matching the ACE may be forwarded and learned.
 Deny: Frames matching the ACE are dropped.

Rate Limiter

Indicates the rate limiter number of the ACE. The allowed range is 1 to 16. When Disabled is displayed, the rate limiter operation is disabled.

Port Copy

Indicates the port copy operation of the ACE. Frames matching the ACE are copied to the port number. The allowed values are Disabled or a specific port number. When Disabled is displayed, the port copy operation is disabled.

Mirror

Specify the mirror operation of this port. The allowed values are:
 Enabled: Frames received on the port are mirrored.
 Disabled: Frames received on the port are not mirrored.

The default value is "Disabled".

Logging

Indicates the logging operation of the ACE. Possible values are:

Enabled: Frames matching the ACE are stored in the System Log.

Disabled: Frames matching the ACE are not logged.

Please note that the System Log memory size and logging rate is limited.

Shutdown

Indicates the port shut down operation of the ACE. Possible values are:

Enabled: If a frame matches the ACE, the ingress port will be disabled.

Disabled: Port shut down is disabled for the ACE.

Counter

The counter indicates the number of times the ACE was hit by a frame.

Modification Buttons

You can modify each ACE (Access Control Entry) in the table using the following buttons:

: Inserts a new ACE before the current row.

: Edits the ACE row.

: Moves the ACE up the list.

: Moves the ACE down the list.

: Deletes the ACE.

: The lowest plus sign adds a new entry at the bottom of the ACE listings.

2-2.4 ACL Sttus

The section describes how to shows the ACL status by different ACL users. Each row describes the ACE that is defined. It is a conflict if a specific ACE is not applied to the hardware due to hardware limitations. The maximum number of ACEs is 256 on each switch.

Web Interface

To display the ACL status in the web interface:

1. Click Configuration, ACL, then ACL status
2. If you want to auto-refresh the information then you need to evoke the "Auto-refresh".
3. Click " Refresh" to refresh the ACL Status

User	Ingress Port	Frame Type	Action	Rate Limiter	Port Copy	Mirror	CPU	CPU Once	Counter	Conflict
No entries										

Parameter description:

User

Indicates the ACL user.

Ingress Port

Indicates the ingress port of the ACE. Possible values are:

Any: The ACE will match any ingress port.

Policy: The ACE will match ingress ports with a specific policy.

Port: The ACE will match a specific ingress port.

Frame Type

Indicates the frame type of the ACE. Possible values are:

Any: The ACE will match any frame type.

EType: The ACE will match Ethernet Type frames. Note that an Ethernet Type based ACE will not get matched by IP and ARP frames.

ARP: The ACE will match ARP/RARP frames.

IPv4: The ACE will match all IPv4 frames.

IPv4/ICMP: The ACE will match IPv4 frames with ICMP protocol.

IPv4/UDP: The ACE will match IPv4 frames with UDP protocol.

IPv4/TCP: The ACE will match IPv4 frames with TCP protocol.

IPv4/Other: The ACE will match IPv4 frames, which are not ICMP/UDP/TCP.

IPv6: The ACE will match all IPv6 standard frames.

Action

Indicates the forwarding action of the ACE.

Permit: Frames matching the ACE may be forwarded and learned.

Deny: Frames matching the ACE are dropped.

Rate Limiter

Indicates the rate limiter number of the ACE. The allowed range is 1 to 16.

When Disabled is displayed, the rate limiter operation is disabled.

Port Copy

Indicates the port copy operation of the ACE. Frames matching the ACE are copied to the port number. The allowed values are Disabled or a specific port number. When Disabled is displayed, the port copy operation is disabled.

Mirror

Specify the mirror operation of this port. The allowed values are:

Enabled: Frames received on the port are mirrored.

Disabled: Frames received on the port are not mirrored.

The default value is "Disabled".

CPU

Forward packet that matched the specific ACE to CPU.

CPU Once

Forward first packet that matched the specific ACE to CPU.

Counter

The counter indicates the number of times the ACE was hit by a frame.

Conflict

Indicates the hardware status of the specific ACE. The specific ACE is not applied to the hardware due to hardware limitations.

Parameter description:

Hash Code Contributors

Source MAC Address

The Source MAC address can be used to calculate the destination port for the frame. Check to enable the use of the Source MAC address, or uncheck to disable. By default, Source MAC Address is enabled.

Destination MAC Address

The Destination MAC Address can be used to calculate the destination port for the frame. Check to enable the use of the Destination MAC Address, or uncheck to disable. By default, Destination MAC Address is disabled.

IP Address

The IP address can be used to calculate the destination port for the frame. Check to enable the use of the IP Address, or uncheck to disable. By default, IP Address is enabled.

TCP/UDP Port Number

The TCP/UDP port number can be used to calculate the destination port for the frame. Check to enable the use of the TCP/UDP Port Number, or uncheck to disable. By default, TCP/UDP Port Number is enabled.

Aggregation Group Configuration

Locality

Indicates the aggregation group type. This field is only valid for stackable switches.

Global: The group members may reside on different units in the stack. The device supports two 8-port global aggregations.

Local: The group members reside on the same unit. Each local aggregation may consist of up to 16 members.

Group ID

Indicates the group ID for the settings contained in the same row. Group ID "Normal" indicates there is no aggregation. Only one group ID is valid per port.

Port Members

Each switch port is listed for each group ID. Select a radio button to include a port in an aggregation, or clear the radio button to remove the port from the aggregation. By default, no ports belong to any aggregation group. Only full duplex ports can join an aggregation and ports must be in the same speed in each group.

2-3.2 LACP

Ports using Link Aggregation Control Protocol (according to IEEE 802.3ad specification) as their trunking method can choose their unique LACP GroupID to form a logic “trunked port”. The benefit of using LACP is that a port makes an agreement with its peer port before it becomes a ready member of a “trunk group” (also called aggregator). LACP is safer than the other trunking method - static trunk.

2-3.2.1 Configuration

This page allows the user to inspect the current LACP port configurations, and possibly change them as well. An LACP trunk group with more than one ready member-ports is a “real trunked” group. An LACP trunk group with only one or less than one ready member-ports is not a “real trunked” group.

Web Interface

To configure the Trunk Aggregation LACP parameters in the web interface:

1. Click Configuration, LACP, Configuration
2. Evoke to enable or disable the LACP on the port of the switch.
Scroll the Key parameter with Auto or Specific Default is Auto.
3. Scroll the Role with Active or Passive. Default is Active
4. Click the save to save the setting
5. If you want to cancel the setting then you need to click the reset button.
It will revert to previously saved values

LACP Port Configuration			
Port	LACP Enabled	Key	Role
1	<input type="checkbox"/>	Auto <input type="text"/>	Active <input type="text"/>
2	<input type="checkbox"/>	Auto <input type="text"/>	Active <input type="text"/>
3	<input type="checkbox"/>	Auto <input type="text"/>	Active <input type="text"/>
4	<input type="checkbox"/>	Auto <input type="text"/>	Active <input type="text"/>
5	<input type="checkbox"/>	Auto <input type="text"/>	Active <input type="text"/>
6	<input type="checkbox"/>	Auto <input type="text"/>	Active <input type="text"/>
7	<input type="checkbox"/>	Auto <input type="text"/>	Active <input type="text"/>
8	<input type="checkbox"/>	Auto <input type="text"/>	Active <input type="text"/>
9	<input type="checkbox"/>	Auto <input type="text"/>	Active <input type="text"/>
10	<input type="checkbox"/>	Auto <input type="text"/>	Active <input type="text"/>
11	<input type="checkbox"/>	Auto <input type="text"/>	Active <input type="text"/>
12	<input type="checkbox"/>	Auto <input type="text"/>	Active <input type="text"/>

Parameter description:

Port

The switch port number.

LACP Enabled

Controls whether LACP is enabled on this switch port. LACP will form an aggregation when 2 or more ports are connected to the same partner. LACP can form max 12 LLAGs per switch and 2 GLAGs per stack.

Key

The Key value incurred by the port, range 1-65535 . The Auto setting will set the key as appropriate by the physical link speed, 10Mb = 1, 100Mb = 2, 1Gb = 3. Using the Specific setting, a user-defined value can be entered. Ports with the same Key value can participate in the same aggregation group, while ports with different keys cannot.

Role

The Role shows the LACP activity status. The Active will transmit LACP packets each second, while Passive will wait for a LACP packet from a partner (speak if spoken to).

2-3.2.2 System Status

This section describes that when you complete to set LACP function on the switch then it provides a status overview for all LACP instances

Web Interface

To display the LACP System status in the web interface:

1. Click Configuration, LACP, System Status
2. If you want to auto-refresh the information then you need to evoke the "Auto-refresh".
3. Click " Refresh" to refresh the LACP System Status.

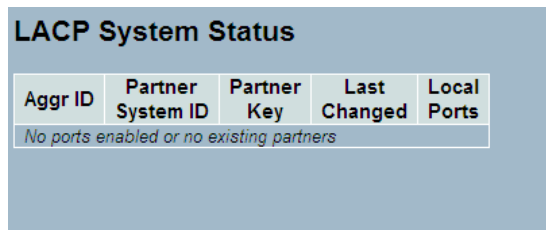

Aggr ID	Partner System ID	Partner Key	Last Changed	Local Ports
<i>No ports enabled or no existing partners</i>				

Parameter description:

Aggr ID

The Aggregation ID associated with this aggregation instance. For LLAG the id is shown as 'isid:aggr-id' and for GLAGs as 'aggr-id'

Partner System ID

The system ID (MAC address) of the aggregation partner.

Partner Key

The Key that the partner has assigned to this aggregation ID.

Last changed

The time since this aggregation changed.

Local Ports

Shows which ports are a part of this aggregation for this switch/stack. The format is: "Switch ID:Port".

2-3.2.3 Port Status

This section describes that when you complete to set LACP function on the switch then it provides a Port Status overview for all LACP instances

Web Interface

To display the LACP Port status in the web interface:

1. Click Configuration, LACP, Port Status
2. If you want to auto-refresh the information then you need to evoke the "Auto-refresh".
3. Click " Refresh" to refresh the LACP Port Status.

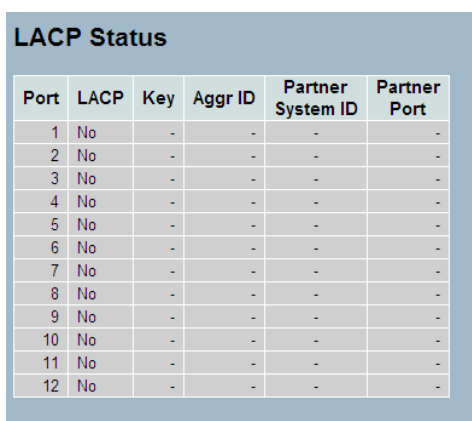

Port	LACP	Key	Aggr ID	Partner System ID	Partner Port
1	No	-	-	-	-
2	No	-	-	-	-
3	No	-	-	-	-
4	No	-	-	-	-
5	No	-	-	-	-
6	No	-	-	-	-
7	No	-	-	-	-
8	No	-	-	-	-
9	No	-	-	-	-
10	No	-	-	-	-
11	No	-	-	-	-
12	No	-	-	-	-

Parameter description:

Port

The switch port number.

LACP

'Yes' means that LACP is enabled and the port link is up. 'No' means that LACP is not enabled or that the port link is down. 'Backup' means that the port could not join the aggregation group but will join if other port leaves. Meanwhile it's LACP status is disabled.

Key

The key assigned to this port. Only ports with the same key can aggregate together.

Aggr ID

The Aggregation ID assigned to this aggregation group. IDs 1 and 2 are GLAGs while IDs 3-14 are LLAGs.

Partner System ID

The partner's System ID (MAC address).

Partner Port

The partner's port number connected to this port.

2-3.2.4 Port Statistics

This section describes that when you complete to set LACP function on the switch then it provides a Port Statistics overview for all LACP instances

Web Interface

To display the LACP Port status in the web interface:

1. Click Configuration, LACP, Port Statistics
2. If you want to auto-refresh the information then you need to evoke the "Auto refresh".
3. Click " Refresh" to refresh the LACP Statistics.

Port	LACP	LACP	Discarded	
	Received	Transmitted	Unknown	Illegal
1	0	0	0	0
2	0	0	0	0
3	0	0	0	0
4	0	0	0	0
5	0	0	0	0
6	0	0	0	0
7	0	0	0	0
8	0	0	0	0
9	0	0	0	0
10	0	0	0	0
11	0	0	0	0
12	0	0	0	0

Parameter description:

Port

The switch port number.

LACP Received

Shows how many LACP frames have been received at each port.

LACP Transmitted

Shows how many LACP frames have been sent from each port.

Discarded

Shows how many unknown or illegal LACP frames have been discarded at each port.

2-4 Spanning Tree

The Spanning Tree Protocol (STP) can be used to detect and disable network loops, and to provide backup links between switches, bridges or routers. This allows the switch to interact with other bridging devices (that is, an STP-compliant switch, bridge or router) in your network to ensure that only one route exists between any two stations on the network, and provide backup links which automatically take over when a primary link goes down.

STP - STP uses a distributed algorithm to select a bridging device (STP-compliant switch, bridge or router) that serves as the root of the spanning tree network. It selects a root port on each bridging device (except for the root device) which incurs the lowest path cost when forwarding a packet from that device to the root device. Then it selects a designated bridging device from each LAN which incurs the lowest path cost when forwarding a packet from that LAN to the root device. All ports connected to designated bridging devices are assigned as designated ports. After determining the lowest cost spanning tree, it enables all root ports and designated ports, and disables all other ports. Network packets are therefore only forwarded through root ports and designated ports, eliminating any possible network loops.

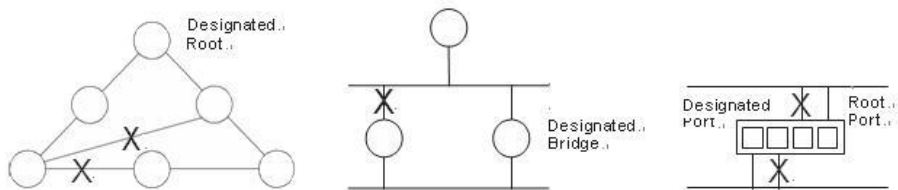

Once a stable network topology has been established, all bridges listen for Hello BPDUs (Bridge Protocol Data Units) transmitted from the Root Bridge. If a bridge does not get a Hello BPDU after a predefined interval (Maximum Age), the bridge assumes that the link to the Root Bridge is down. This bridge will then initiate negotiations with other bridges to reconfigure the network to reestablish a valid network topology.

2-4.1 Bridge Settings

The section describes that how to configure the Spanning Tree Bridge and STP System settings. It allows you to configure STP System settings are used by all STP Bridge instance in the Switch Stack.

Web Interface

To configure the Spanning Tree Bridge Settings parameters in the web interface:

1. Click Configuration, Spanning Tree, Bridge Settings
2. Scroll to select the parameters and write down available value of parameters in blank field in Basic Settings
3. Evoke to enable or disable the parameters and write down available value of parameters in blank field in Advanced settings
4. Click the save to save the setting
5. If you want to cancel the setting then you need to click the Reset button. It will revert to previously saved values

Basic Settings	
Protocol Version	MSTP
Bridge Priority	128
Forward Delay	15
Max Age	20
Maximum Hop Count	20
Transmit Hold Count	6

Advanced Settings	
Edge Port BPDU Filtering	<input type="checkbox"/>
Edge Port BPDU Guard	<input type="checkbox"/>
Port Error Recovery	<input type="checkbox"/>
Port Error Recovery Timeout	

Save Reset

Parameter description:

Basic Settings

Protocol Version

The STP protocol version setting. Valid values are STP, RSTP and MSTP.

Bridge Priority

Controls the bridge priority. Lower numeric values have better priority. The bridge priority plus the MSTI instance number, concatenated with the 6-byte MAC address of the switch forms a *Bridge Identifier*. For MSTP operation, this is the priority of the CIST. Otherwise, this is the priority of the STP/RSTP bridge.

Forward Delay

The delay used by STP Bridges to transit Root and Designated Ports to Forwarding (used in STP compatible mode). Valid values are in the range 4 to 30 seconds.

Max Age

The maximum age of the information transmitted by the Bridge when it is the Root Bridge. Valid values are in the range 6 to 40 seconds, and MaxAge must be $\leq (\text{FwdDelay}-1)*2$.

Maximum Hop Count

This defines the initial value of remaining Hops for MSTI information generated at the boundary of an MSTI region. It defines how many bridges a root bridge can distribute its BPDU information to. Valid values are in the range 6 to 40 hops.

Transmit Hold Count

The number of BPDU's a bridge port can send per second. When exceeded, transmission of the next BPDU will be delayed. Valid values are in the range 1 to 10 BPDU's per second.

Advanced Settings

Edge Port BPDU Filtering

Control whether a port *explicitly* configured as Edge will transmit and receive BPDUs.

Edge Port BPDU Guard

Control whether a port *explicitly* configured as Edge will disable itself upon reception of a BPDU. The port will enter the *error-disabled* state, and will be removed from the active topology.

Port Error Recovery

Control whether a port in the *error-disabled* state automatically will be enabled after a certain time. If recovery is not enabled, ports have to be disabled and re-enabled for normal STP operation. The condition is also cleared by a system reboot.

Port Error Recovery Timeout

The time to pass before a port in the *error-disabled* state can be enabled. Valid values are between 30 and 86400 seconds (24 hours).

2-4.2 MSTI Mapping

When you implement an Spanning Tree protocol on the switch that the bridge instance. The CIST is not available for explicit mapping, as it will

receive the VLANs not explicitly mapped. Due to the reason that you need to set the list of VLANs mapped to the MSTI. The VLANs must be separated with comma and/or space. A VLAN can only be mapped to one MSTI. An unused MSTI should just be left empty. (I.e. not having any VLANs mapped to it.)

This section describes it allows the user to inspect the current STP MSTI bridge instance priority configurations, and possibly change them as well.

Web Interface

To configure the Spanning Tree MSTI Mapping parameters in the web interface:

1. Click Configuration, Spanning Tree, MSTI Mapping
2. Specify the configuration identification parameters in the field Specify the VLANs Mapped blank field.
3. Click the save to save the setting
4. If you want to cancel the setting then you need to click the Reset button. It will revert to previously saved values

MSTI	VLANs Mapped
MSTI1	<input type="text"/>
MSTI2	<input type="text"/>
MSTI3	<input type="text"/>
MSTI4	<input type="text"/>
MSTI5	<input type="text"/>

Parameter description:

Configuration Identification

Configuration Name

The name identifying the VLAN to MSTI mapping. Bridges must share the name and revision (see below), as well as the VLAN-to-MSTI mapping configuration in order to share spanning trees for MSTI's (Intra-region). The name is at most 32 characters.

Configuration Revision

The revision of the MSTI configuration named above. This must be an integer between 0 and 65535.

MSTI Mapping

MSTI

The bridge instance. The CIST is not available for explicit mapping, as it will receive the VLANs not explicitly mapped.

VLANs Mapped

The list of VLANs mapped to the MSTI. The VLANs must be separated with comma and/or space. A VLAN can only be mapped to one MSTI. An unused MSTI should just be left empty. (i.e. not having any VLANs

2-4.3 MSTI Priorities

When you implement an Spanning Tree protocol on the switch that the bridge instance. The CIST is the default instance which is always active. For controls the bridge priority. Lower numeric values have better priority. The bridge priority plus the MSTI instance number, concatenated with the 6-byte MAC address of the switch forms a Bridge Identifier

The section describes it allows the user to inspect the current STP MSTI bridge instance priority configurations, and possibly change them as well.

Web Interface

To configure the Spanning Tree MSTI Priorities parameters in the web interface:

1. Click Configuration, Spanning Tree, MSTI Priorities
2. Scroll the Priority maximum is 240. Default is 128.
3. Click the save to save the setting
4. If you want to cancel the setting then you need to click the Reset button.
It will revert to previously saved values

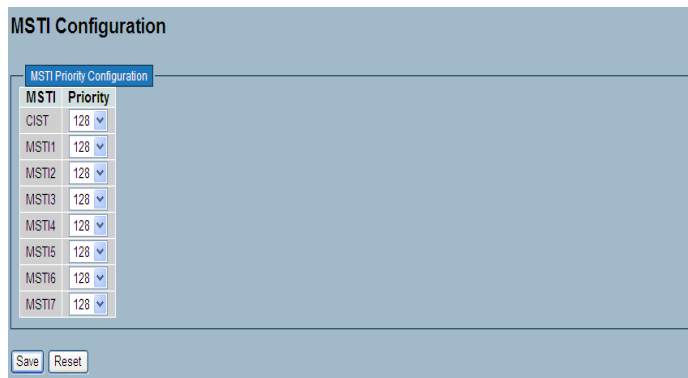

The screenshot shows the 'MSTI Configuration' web interface. It features a table with two columns: 'MSTI' and 'Priority'. The table lists instances from CIST to MSTI7, all with a priority of 128. Below the table are 'Save' and 'Reset' buttons.

MSTI	Priority
CIST	128
MSTI1	128
MSTI2	128
MSTI3	128
MSTI4	128
MSTI5	128
MSTI6	128
MSTI7	128

Parameter description:

MSTI

The bridge instance. The CIST is the default instance, which is always active.

Priority

Controls the bridge priority. Lower numeric values have better priority. The bridge priority plus the MSTI instance number, concatenated with the 6-byte MAC address of the switch forms a Bridge Identifier.

2-4.4 CIST Ports

When you implement an Spanning Tree protocol on the switch that the bridge instance. You need to configure the CIST Ports. The section describes it allows the user to inspect the to inspect the current STP CIST port configurations, and possibly change them as well.

Web Interface

To configure the Spanning Tree CIST Ports parameters in the web interface:

1. Click Configuration, Spanning Tree, CIST Ports
2. Scroll and evoke to set all parameters of CIST Aggregated Port Configuration.
3. Evoke to enable or disable the STP, then scoll and evoke to set all parameters of the CIST normal Port configuration.
4. Click the save to save the setting
5. If you want to cancel the setting then you need to click the Reset button. It will revert to previously saved values

STP CIST Port Configuration									
CIST Aggregated Port Configuration									
Port	STP Enabled	Path Cost	Priority	Admin Edge	Auto Edge	Restricted Role	TCN	BPDU Guard	Point-to-point
-	<input checked="" type="checkbox"/>	Auto	128	Edge	<input checked="" type="checkbox"/>	<input type="checkbox"/>	<input type="checkbox"/>	<input type="checkbox"/>	Forced True
CIST Normal Port Configuration									
Port	STP Enabled	Path Cost	Priority	Admin Edge	Auto Edge	Restricted Role	TCN	BPDU Guard	Point-to-point
1	<input checked="" type="checkbox"/>	Auto	128	Edge	<input checked="" type="checkbox"/>	<input type="checkbox"/>	<input type="checkbox"/>	<input type="checkbox"/>	Auto
2	<input checked="" type="checkbox"/>	Auto	128	Edge	<input checked="" type="checkbox"/>	<input type="checkbox"/>	<input type="checkbox"/>	<input type="checkbox"/>	Auto
3	<input checked="" type="checkbox"/>	Auto	128	Edge	<input checked="" type="checkbox"/>	<input type="checkbox"/>	<input type="checkbox"/>	<input type="checkbox"/>	Auto
4	<input checked="" type="checkbox"/>	Auto	128	Edge	<input checked="" type="checkbox"/>	<input type="checkbox"/>	<input type="checkbox"/>	<input type="checkbox"/>	Auto
5	<input checked="" type="checkbox"/>	Auto	128	Edge	<input checked="" type="checkbox"/>	<input type="checkbox"/>	<input type="checkbox"/>	<input type="checkbox"/>	Auto
6	<input checked="" type="checkbox"/>	Auto	128	Edge	<input checked="" type="checkbox"/>	<input type="checkbox"/>	<input type="checkbox"/>	<input type="checkbox"/>	Auto
7	<input checked="" type="checkbox"/>	Auto	128	Edge	<input checked="" type="checkbox"/>	<input type="checkbox"/>	<input type="checkbox"/>	<input type="checkbox"/>	Auto
8	<input checked="" type="checkbox"/>	Auto	128	Edge	<input checked="" type="checkbox"/>	<input type="checkbox"/>	<input type="checkbox"/>	<input type="checkbox"/>	Auto

Parameter description:

Port

The switch port number of the logical STP port.

STP Enabled

Controls whether STP is enabled on this switch port.

Path Cost

Controls the path cost incurred by the port. The Auto setting will set the path cost as appropriate by the physical link speed, using the 802.1D recommended values. Using the Specific setting, a user-defined value can be entered. The path cost is used when establishing the active topology of the network. Lower path cost ports are chosen as forwarding ports in favour of higher path cost ports. Valid values are in the range 1 to 200000000.

Priority

Controls the port priority. This can be used to control priority of ports having identical port cost. (See above).

operEdge (state flag)

Operational flag describing whether the port is connecting directly to edge devices. (No Bridges attached). Transition to the forwarding state is faster for edge ports (having operEdge true) than for other ports. The value of this flag is based on AdminEdge and AutoEdge fields. This flag is displayed as Edge in Monitor->Spanning Tree -> STP Detailed Bridge Status.

AdminEdge

Controls whether the *operEdge* flag should start as set or cleared. (The initial *operEdge* state when a port is initialized).

AutoEdge

Controls whether the bridge should enable automatic edge detection on the bridge port. This allows *operEdge* to be derived from whether BPDU's are received on the port or not.

Restricted Role

If enabled, causes the port not to be selected as Root Port for the CIST or any MSTI, even if it has the best spanning tree priority vector. Such a port will be selected as an Alternate Port after the Root Port has been selected. If set, it can cause lack of spanning tree connectivity. It can be set by a network administrator to prevent bridges external to a core region of the network influence the spanning tree active topology, possibly because those bridges are not under the full control of the administrator. This feature is also known as Root Guard.

Restricted TCN

If enabled, causes the port not to propagate received topology change notifications and topology changes to other ports. If set it can cause temporary loss of connectivity after changes in a spanning tree's active topology as a result of persistently incorrect learned station location information. It is set by a network administrator to prevent bridges external to a core region of the network, causing address flushing in that region, possibly because those bridges are not under the full control of the administrator or the physical link state of the attached LANs transits frequently.

BPDU Guard

If enabled, causes the port to disable itself upon receiving valid BPDU's. Contrary to the similar bridge setting, the port Edge status does not effect this setting.

A port entering error-disabled state due to this setting is subject to the bridge Port Error Recovery setting as well.

Point2Point

Controls whether the port connects to a point-to-point LAN rather than to a shared medium. This can be automatically determined, or forced either true or false. Transition to the forwarding state is faster for point-to-point LANs than for shared media.

2-4.5 MSTI Ports

The section describes it allows the user to inspect the current STP MSTI port configurations, and possibly change them as well.

An MSTI port is a virtual port, which is instantiated separately for each active CIST (physical) port for each MSTI instance configured on and applicable to the port. The MSTI instance must be selected before displaying actual MSTI port configuration options. It contains MSTI port settings for physical and aggregated ports. The aggregation settings are stack global.

Web Interface

To configure the Spanning Tree MSTI Port Configuration parameters in the web interface:

1. Click Configuration, Spanning Tree, MSTI Ports
2. Scroll to select the MST1 or other MSTI Port
3. Click Get to set the detail parameters of the MSTI Ports.
4. Scroll to set all parameters of the MSTI Port configuration.
5. Click the save to save the setting
6. If you want to cancel the setting then you need to click the Reset button.
It will revert to previously saved values

MSTI Port Configuration

Select MSTI

MST1

MST1 MSTI Port Configuration

MSTI Aggregated Ports Configuration

Port	Path Cost	Priority
-	Auto <input type="button" value="v"/>	128 <input type="button" value="v"/>

MSTI Normal Ports Configuration

Port	Path Cost	Priority
1	Auto <input type="button" value="v"/>	128 <input type="button" value="v"/>
2	Auto <input type="button" value="v"/>	128 <input type="button" value="v"/>
3	Auto <input type="button" value="v"/>	128 <input type="button" value="v"/>
4	Auto <input type="button" value="v"/>	128 <input type="button" value="v"/>
5	Auto <input type="button" value="v"/>	128 <input type="button" value="v"/>
6	Auto <input type="button" value="v"/>	128 <input type="button" value="v"/>
7	Auto <input type="button" value="v"/>	128 <input type="button" value="v"/>
8	Auto <input type="button" value="v"/>	128 <input type="button" value="v"/>
9	Auto <input type="button" value="v"/>	128 <input type="button" value="v"/>
10	Auto <input type="button" value="v"/>	128 <input type="button" value="v"/>
11	Auto <input type="button" value="v"/>	128 <input type="button" value="v"/>
12	Auto <input type="button" value="v"/>	128 <input type="button" value="v"/>
13	Auto <input type="button" value="v"/>	128 <input type="button" value="v"/>
14	Auto <input type="button" value="v"/>	128 <input type="button" value="v"/>

Parameter description:

Port

The switch port number of the corresponding STP CIST (and MSTI) port.

Path Cost

Controls the path cost incurred by the port. The Auto setting will set the path cost as appropriate by the physical link speed, using the 802.1D recommended values. Using the Specific setting, a user-defined value can be entered. The path cost is used when establishing the active topology of the network. Lower path cost ports are chosen as forwarding ports in favour of higher path cost ports. Valid values are in the range 1 to 200000000.

Priority

Controls the port priority. This can be used to control priority of ports having identical port cost. (See above).

2-4.6 Bridge Status

After you complete the MSTI Port configuration the you could to ask the switch display the Bridge Status. The Section provides a status overview of all STP bridge instances. The displayed table contains a row for each STP bridge instance, where the column displays the following information:

Web Interface

To display the STP Bridges status in the web interface:

1. Click Configuration, Spanning Tree, STP Bridges
2. If you want to auto-refresh the information then you need to evoke the “Auto-refresh”.
3. Click “ Refresh” to refresh the STP Bridges.

STP Bridges							
MSTI	Bridge ID	Root			Topology Flag	Topology Change Last	
		ID	Port	Cost			
CIST	80-00-00-01:C1:00:00:00	80-00-00-01:C1:00:00:00	-	0	Steady	-	

Parameter description:

MSTI

The Bridge Instance. This is also a link to the STP Detailed Bridge Status.

Bridge ID

The Bridge ID of this Bridge instance.

Root ID

The Bridge ID of the currently elected root bridge.

Root Port

The switch port currently assigned the root port role.

Root Cost

Root Path Cost. For the Root Bridge it is zero. For all other Bridges, it is the sum of the Port Path Costs on the least cost path to the Root Bridge.

Topology Flag

The current state of the Topology Change Flag of this Bridge instance.

Topology Change Last

The time since last Topology Change occurred.

2-4.7 Port Status

After you complete the STP configuration the you could to ask the switch display the STP Port Status. The Section provides you to ask switch to display the STP CIST port status for physical ports of the currently selected switch.:

Web Interface

To display the STP Port status in the web interface:

1. Click Configuration, Spanning Tree, STP Port Status
2. If you want to auto-refresh the information then you need to evoke the “Auto-refresh”.
3. Click “ Refresh“ to refresh the STP Bridges.

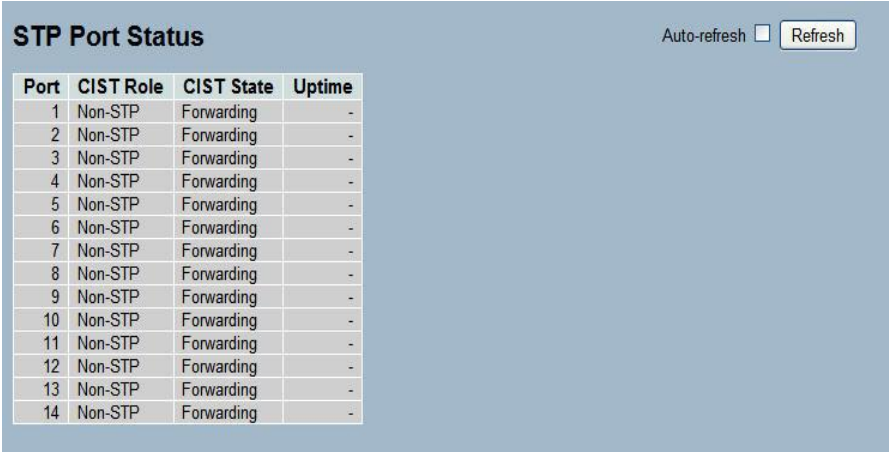

The screenshot shows a web interface titled "STP Port Status". In the top right corner, there is an "Auto-refresh" checkbox (which is unchecked) and a "Refresh" button. Below this is a table with four columns: "Port", "CIST Role", "CIST State", and "Uptime". The table contains 14 rows of data, all showing "Non-STP" for the role and "Forwarding" for the state, with a "-" in the uptime column.

Port	CIST Role	CIST State	Uptime
1	Non-STP	Forwarding	-
2	Non-STP	Forwarding	-
3	Non-STP	Forwarding	-
4	Non-STP	Forwarding	-
5	Non-STP	Forwarding	-
6	Non-STP	Forwarding	-
7	Non-STP	Forwarding	-
8	Non-STP	Forwarding	-
9	Non-STP	Forwarding	-
10	Non-STP	Forwarding	-
11	Non-STP	Forwarding	-
12	Non-STP	Forwarding	-
13	Non-STP	Forwarding	-
14	Non-STP	Forwarding	-

Parameter description:

Port

The switch port number of the logical STP port.

CIST Role

The current STP port role of the CIST port. The port role can be one of the following values: AlternatePort BackupPort RootPort DesignatedPort Disabled.

CIST State

The current STP port state of the CIST port. The port state can be one of the following values: Blocking Learning Forwarding.

Uptime

The time since the bridge port was last initialized.

2-4.8 Port Statistics

After you complete the STP configuration then you could to let the switch display the STP Statistics. The Section provides you to ask switch to display the STP Statistics detail counters of bridge ports in the currently selected switch.

Web Interface

To display the STP Port status in the web interface:

1. Click Configuration, Spanning Tree, Port Statistics
2. If you want to auto-refresh the information then you need to evoke the "Auto-refresh".
3. Click " Refresh" to refresh the STP Bridges.

Port	Transmitted				Received				Discarded	
	MSTP	RSTP	STP	TCN	MSTP	RSTP	STP	TCN	Unknown	Illegal
No ports enabled										

Parameter description:

Port

The switch port number of the logical STP port.

MSTP

The number of MSTP Configuration BPDU's received/transmitted on the port.

RSTP

The number of RSTP Configuration BPDU's received/transmitted on the port.

STP

The number of legacy STP Configuration BPDU's received/transmitted on the port.

TCN

The number of (legacy) Topology Change Notification BPDU's received/transmitted on the port.

Discarded Unknown

The number of unknown Spanning Tree BPDU's received (and discarded) on the port.

Discarded Illegal

The number of illegal Spanning Tree BPDU's received (and discarded) on the port.

2-5 IGMP Snooping

The function, is used to establish the multicast groups to forward the multicast packet to the member ports, and, in nature, avoids wasting the bandwidth while IP multicast packets are running over the network. This is because a switch that does not support IGMP or IGMP Snooping can not tell the multicast packet from the broadcast packet, so it can only treat them all as the broadcast packet. Without IGMP Snooping, the multicast packet forwarding function is plain and nothing is different from broadcast packet.

A switch supported IGMP Snooping with the functions of query, report and leave, a type of packet exchanged between IP Multicast Router/Switch and IP Multicast Host, can update the information of the Multicast table when a member (port) joins or leaves an IP Multicast Destination Address. With this function, once a switch receives an IP multicast packet, it will forward the packet to the members who joined in a specified IP multicast group before.

The packets will be discarded by the IGMP Snooping if the user transmits multicast packets to the multicast group that had not been built up in advance. IGMP mode enables the switch to issue IGMP function that you enable IGMP proxy or snooping on the switch, which connects to a router closer to the root of the tree. This interface is the upstream interface. The router on the upstream interface should be running IGMP.

2-5.1 Basic Configuration

The section describes how to set the basic IGMP snooping on the switch, which connects to a router closer to the root of the tree. This interface is the upstream interface. The router on the upstream interface should be running IGMP.

Web Interface

To configure the IGMP Snooping parameters in the web interface:

1. Click Configuration, IGMP Snooping, Basic Configuration
2. Evoke to select enable or disable which Global configuration
3. Evoke which port wants to become a Router Port or enable/ disable the Fast Leave function..
4. Scroll to set the Throtting parameter.
5. Click the save to save the setting
6. If you want to cancel the setting then you need to click the Reset button.
It will revert to previously saved values

IGMP Snooping Configuration

Global Configuration

Snooping Enabled

Unregistered IPMC Flooding Enabled

Leave Proxy Enabled

Proxy Enabled

Port Related Configuration

Port	Router Port	Fast Leave	Throttling
1	<input type="checkbox"/>	<input type="checkbox"/>	unlimited
2	<input type="checkbox"/>	<input type="checkbox"/>	unlimited
3	<input type="checkbox"/>	<input type="checkbox"/>	unlimited
4	<input type="checkbox"/>	<input type="checkbox"/>	unlimited
5	<input type="checkbox"/>	<input type="checkbox"/>	unlimited
6	<input type="checkbox"/>	<input type="checkbox"/>	unlimited
7	<input type="checkbox"/>	<input type="checkbox"/>	unlimited
8	<input type="checkbox"/>	<input type="checkbox"/>	unlimited
9	<input type="checkbox"/>	<input type="checkbox"/>	unlimited
10	<input type="checkbox"/>	<input type="checkbox"/>	unlimited
11	<input type="checkbox"/>	<input type="checkbox"/>	unlimited
12	<input type="checkbox"/>	<input type="checkbox"/>	unlimited
13	<input type="checkbox"/>	<input type="checkbox"/>	unlimited
14	<input type="checkbox"/>	<input type="checkbox"/>	unlimited

Parameter description:

Snooping Enabled

Enable the Global IGMP Snooping.

Unregistered IPMC Flooding enabled

Enable unregistered IPMC traffic flooding.

Leave Proxy Enabled

Enable IGMP Leave Proxy. This feature can be used to avoid forwarding unnecessary leave messages to the router side.

Proxy Enabled

Enable IGMP Proxy. This feature can be used to avoid forwarding unnecessary join and leave messages to the router side.

Router Port

Specify which ports act as router ports. A router port is a port on the Ethernet switch that leads towards the Layer 3 multicast device or IGMP querier.

If an aggregation member port is selected as a router port, the whole aggregation will act as a router port.

Fast Leave

Enable the fast leave on the port.

Throttling

Enable to limit the number of multicast groups to which a switch port can belong.

2-5.2 VLAN Configuration

The section describes the VLAN configuration setting process integrated with IGMP Snooping function. For Each setting page shows up to 99 entries from the VLAN table, default being 20, selected through the "entries per page" input field. When first visited, the web page will show the first 20 entries from the beginning of the VLAN Table. The first displayed will be the one with the lowest VLAN ID found in the VLAN Table. The "VLAN" input fields allow the user to select the starting point in the VLAN Table. Clicking the button will update the displayed table starting from that or the next closest VLAN Table match.

Web Interface

To configure the IGMP Snooping VLAN Configuration in the web interface:

1. Click Configuration, IGMP Snooping, VLAN Configuration
2. Evoke to select enable or disable Snooping , IGMP Querier
Specify the parameters in the blank field.
3. Click the refresh to update the data or click << or >> to display previous entry or next entry.
4. Click the save to save the setting
5. If you want to cancel the setting then you need to click the Reset button.
It will revert to previously saved values

IGMP Snooping VLAN Configuration

Refresh |<< >>

Start from VLAN with entries per page.

VLAN ID	Snooping Enabled	IGMP Querier	RV	QI (sec)	QRI (0.1 sec)	LMQI (0.1 sec)	URI (sec)
1	<input type="checkbox"/>	<input type="checkbox"/>	-	-	-	-	-

Save Reset

Parameter description:

Snooping Enabled

Enable the Global IGMP Snooping.

Unregistered IPMC Flooding enabled

Enable unregistered IPMC traffic flooding.

Leave Proxy Enabled

Enable IGMP Leave Proxy. This feature can be used to avoid forwarding unnecessary leave messages to the router side.

Proxy Enabled

Enable IGMP Proxy. This feature can be used to avoid forwarding unnecessary join and leave messages to the router side.

Router Port

Specify which ports act as router ports. A router port is a port on the Ethernet switch that leads towards the Layer 3 multicast device or IGMP querier.

If an aggregation member port is selected as a router port, the whole aggregation will act as a router port.

Fast Leave

Enable the fast leave on the port.

Throttling

Enable to limit the number of multicast groups to which a switch port can belong.

2-5.3 Port Group Fitering

The section describes how to set the IGMP Port Group Filtering? With the IGMP filtering feature, an user can exert this type of control. In some network Application environments, as like the metropolitan or multiple-dwelling unit (MDU) installations, an user might want to control the multicast groups to which a user on a switch port can belong. It allows the user to control the distribution of multicast services, such as IP/TV, based on some type of subscription or service plan.

With this feature, you can filter multicast joins on a per-port basis by configuring IP multicast profiles and associating them with individual switch ports. An IGMP profile can contain one or more multicast groups and specifies whether access to the group is permitted or denied. If an IGMP profile denying access to a multicast group is applied to a switch port, the IGMP join report requesting the stream of IP multicast traffic is dropped, and the port is not allowed to receive IP multicast traffic from that group. If the filtering action permits access to the multicast group, the IGMP report from the port is forwarded for normal processing.

IGMP filtering controls only IGMP membership join reports and has no relationship to the function that directs the forwarding of IP multicast traffic.

Web Interface

To configure the IGMP Snooping Port Group Configuration in the web interface:

1. Click Configuration, IGMP Snooping, Port Group Filtering
2. Click Add new Filtering Group
3. Scroll the Port to enable the Port Group Filtering.
Specify the Filtering Groups in the blank field.
4. Click the save to save the setting
5. If you want to cancel the setting then you need to click the Reset button.
It will revert to previously saved values



The screenshot shows a web interface titled "IGMP Snooping Port Group Filtering Configuration". At the top, there are three tabs: "Delete", "Port", and "Filtering Groups". Below the tabs is a text input field with the placeholder text "Add new Filtering Group". At the bottom of the interface, there are two buttons: "Save" and "Reset".

IGMP Snooping Port Group Filtering Configuration

Delete	Port	Filtering Groups
<input type="checkbox"/>	14	224
<input type="checkbox"/>	11	239
<input type="checkbox"/>	1	

Parameter description:

Delete

Check to delete the entry. It will be deleted during the next save.

Port

The logical port for the settings.

Filtering Groups

The IP Multicast Group that will be filtered.

Adding New Filtering Group

2-5.4 Status

After you complete the IGMP Snooping configuration, then you could to let the switch display the IGMP Snooping Status. The Section provides you to let switch to display the IGMP Snooping detail status.

Web Interface

To display the IGMP Snooping status in the web interface:

1. Click Configuration, IGMP Snooping, Status
2. If you want to auto-refresh the information then you need to evoke the "Auto-refresh".
3. Click " Refresh" to refresh the IGMP Snooping Status.
4. Click " Clear" to clear the IGMP Snooping Status.

VLAN ID	Querier Version	Host Version	Querier Status	Queries Transmitted	Queries Received	V1 Reports Received	V2 Reports Received	V3 Reports Received	V2 Leaves Received
Router Port									
Port	Status								
1	-								
2	-								
3	-								
4	-								
5	-								
6	-								
7	-								
8	-								
9	-								
10	-								
11	-								
12	-								

Parameter description:

VLAN ID

The VLAN ID of the entry.

Querier Version

Working Querier Version currently.

Host Version

Working Host Version currently.

Querier Status

Shows the Querier status is "ACTIVE" or "IDLE".

Queries Transmitted

The number of Transmitted Queries.

Queries Received

The number of Received Queries.

V1 Reports Received

The number of Received V1 Reports.

V2 Reports Received

The number of Received V2 Reports.

V3 Reports Received

The number of Received V3 Reports.

V2 Leaves Received

The number of Received V2 Leaves.

2-5.5 Group Information

After you complete to set the IGMP Snooping function then you could let the switch to display the IGMP Snooping Group Information. Entries in the IGMP Group Table are shown on this page. The IGMP Group Table is sorted first by VLAN ID, and then by group. The will use the last entry of the currently displayed table as a basis for the next lookup. When the end is reached the text "No more entries" is shown in the displayed table. Use the button to start over.

Web Interface

To display the IGMP Snooping Group Information in the web interface:

1. Click Configuration, IGMP Snooping, Group Information
2. If you want to auto-refresh the information then you need to evoke the "Auto-refresh".
3. Click " Refresh" to refresh a entry of the IGMP Snooping Groups Information.
4. Click "<< or >> " to move to previous or next entry.

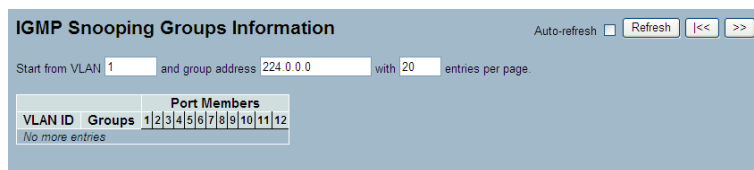

Parameter description:

Navigating the IGMP Group Table

The "Start from VLAN", and "group" input fields allow the user to select the starting point in the IGMP Group Table. The will use the last entry of the currently displayed table as a basis for the next lookup. When the end is reached the text "No more entries" is shown in the displayed table.

IGMP Group Table Columns

VLAN ID

VLAN ID of the group.

Groups

Group address of the group displayed.

Port Members

Ports under this group.

2-5.6 IPv4 SSM information

Source Specific Multicast (SSM) is a datagram delivery model that best supports one-to-many applications, also known as broadcast applications. SSM is a core network technology of IP multicast targeted for audio and video broadcast application environments.

For the SSM delivery mode, an IP multicast receiver host must use IGMP Version 3 (IGMPv3) to subscribe to channel (S, G). By subscribing to this channel, the receiver host is indicating that it wants to receive IP multicast traffic sent by source host S to group G. The network will deliver IP multicast packets from source host S to group G to all hosts in the network that have subscribed to the channel (S, G).

SSM does not require group address allocation within the network, only within each source host. Different applications running on the same source host must use different SSM groups. Different applications running on different source hosts can arbitrarily reuse SSM group addresses without causing any excess traffic on the network.

Addresses in the range 232.0.0.0/8 (232.0.0.0 to 232.255.255.255) are reserved for SSM by IANA. In the switch, you can configure SSM for arbitrary IP multicast addresses also.

Web Interface

To display the IGMPv3 IPv4 SSM Information in the web interface:

1. Click Configuration, IGMP Snooping, IPv4 SSM Information
2. If you want to auto-refresh the information then you need to evoke the "Auto-refresh".
3. Click "Refresh" to refresh a entry of the IGMPv3 IPv4 SSM Information.
4. Click "<< or >>" to move to previous or next entry.

VLAN ID	Group	Port No.	Mode	Source Address	Type
No more entries					

Parameter description:

Navigating the IGMPv3 Information Table

Each page shows up to 99 entries from the IGMPv3 SSM (Source Specific Multicast) Information table, default being 20, selected through the "entries per page" input field. When first visited, the web page will show the first 20 entries from the beginning of the IGMPv3 Information Table.

The "Start from VLAN", and "group" input fields allow the user to select the starting point in the IGMPv3 Information Table. Clicking the button will update the displayed table starting from that or the closest next IGMPv3 Information Table match. In addition, the two input fields will - upon a button

click - assume the value of the first displayed entry, allowing for continuous refresh with the same start address.

The will use the last entry of the currently displayed table as a basis for the next lookup. When the end is reached the text "No more entries" is shown in the displayed table. Use the button to start over.

IGMPv3 Information Table Columns

VLAN ID

VLAN ID of the group.

Group

Group address of the group displayed.

Port

Switch port number.

Mode

Indicates the filtering mode maintained per (VLAN ID, port number, Group Address) basis. It can be either Include or Exclude.

Source Address

IP Address of the source. Currently, system limits the total number of IP source addresses for filtering to be 128.

Type

Indicates the Type. It can be either Allow or Deny.

2-6 MLD Snooping

Curiously enough, a network node that acts as a source of IPv6 multicast traffic is only an indirect participant in MLD snooping—it just provides multicast traffic, and MLD doesn't interact with it. (Note, however, that in an application like desktop conferencing a network node may act as both a source and an MLD host; but MLD interacts with that node only in its role as an MLD host.)

A source node creates multicast traffic by sending packets to a multicast address. In IPv6, addresses with the first eight bits set (that is, "FF" as the first two characters of the address) are multicast addresses, and any node that listens to such an address will receive the traffic sent to that address. Application software running on the source and destination systems cooperates to determine what multicast address to use. (Note that this is a function of the application software, not of MLD.)

When MLD snooping is enabled on a VLAN, the switch acts to minimize unnecessary multicast traffic. If the switch receives multicast traffic destined for a given multicast address, it forwards that traffic only to ports on the VLAN that have MLD hosts for that address. It drops that traffic for ports on the VLAN that have no MLD hosts

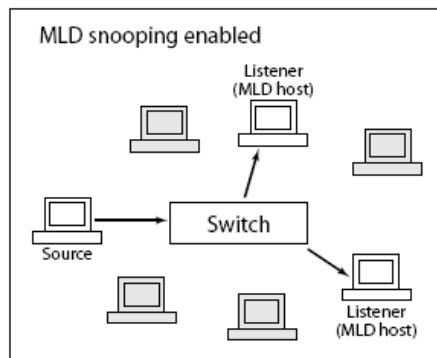

2-6.1 Basic Configuration

The section will let you understand how to configure the MLD Snooping basic configuration and the parameters .

Web Interface

To configure the MLD Snooping Configuration in the web interface:

1. Click Configuration, MLD Snooping, Basic Configuration
2. Evoke to enable or disable the Global configuration parameters
Evoke the port to join Router port and Fast Leave.
3. Scroll to select the Throtting mode with unlimited or 1 to 10
4. Click the save to save the setting
5. If you want to cancel the setting then you need to click the Reset button.
It will revert to previously saved values

MLD Snooping Configuration			
Global Configuration			
Snooping Enabled	<input type="checkbox"/>		
Unregistered IPMCv6 Flooding Enabled	<input checked="" type="checkbox"/>		
Leave Proxy Enabled	<input type="checkbox"/>		
Proxy Enabled	<input type="checkbox"/>		
Port Related Configuration			
Port	Router Port	Fast Leave	Throtting
1	<input type="checkbox"/>	<input type="checkbox"/>	unlimited
2	<input type="checkbox"/>	<input type="checkbox"/>	unlimited
3	<input type="checkbox"/>	<input type="checkbox"/>	unlimited
4	<input type="checkbox"/>	<input type="checkbox"/>	unlimited
5	<input type="checkbox"/>	<input type="checkbox"/>	unlimited
6	<input type="checkbox"/>	<input type="checkbox"/>	unlimited
7	<input type="checkbox"/>	<input type="checkbox"/>	unlimited
8	<input type="checkbox"/>	<input type="checkbox"/>	unlimited
9	<input type="checkbox"/>	<input type="checkbox"/>	unlimited
10	<input type="checkbox"/>	<input type="checkbox"/>	unlimited
11	<input type="checkbox"/>	<input type="checkbox"/>	unlimited
12	<input type="checkbox"/>	<input type="checkbox"/>	unlimited

Save Reset

Parameter description:

Snooping Enabled

Enable the Global MLD Snooping.

Unregistered IPMC Flooding enabled

Enable unregistered IPMCv6 traffic flooding. Please note that disabling unregistered IPMCv6 traffic flooding may lead to failure of Neighbor Discovery.

Leave Proxy Enabled

Enable MLD Leave Proxy. This feature can be used to avoid forwarding unnecessary leave messages to the router side.

Proxy Enabled

Enable MLD Proxy. This feature can be used to avoid forwarding unnecessary join and leave messages to the router side.

Router Port

Specify which ports act as router ports. A router port is a port on the Ethernet switch that leads towards the Layer 3 multicast device or MLD querier. If an aggregation member port is selected as a router port, the whole aggregation will act as a router port.

Fast Leave

Enable the fast leave on the port.

Throttling

Enable to limit the number of multicast groups to which a switch port can belong.

2-6.2 VLAN Configuration

When MLD snooping is enabled on a VLAN, the switch acts to minimize unnecessary multicast traffic. If the switch receives multicast traffic destined for a given multicast address, it forwards that traffic only to ports on the VLAN that have MLD hosts for that address. It drops that traffic for ports on the VLAN that have no MLD hosts

The will use the last entry of the currently displayed entry as a basis for the next lookup. When the end is reached the text "No more entries" is shown in the displayed table. Use the button to start over.

Web Interface

To configure the MLD Snooping VLAN Configuration in the web interface:

1. Click Configuration, MLD Snooping, VLAN Configuration
2. Specify the VLAN ID with entries per page.
3. Click " Refresh " to refresh a entry of the MLD Snooping VLAN Configuration Information.
4. Click "<< or >> " to move to previous or next entry.

MLD Snooping VLAN Configuration

Start from VLAN 1 with 20 entries per page.

VLAN ID	Snooping Enabled	MLD Querier	RV	QI (sec)	QRI (0.1 sec)	LLQI (0.1 sec)	URI (sec)
1	<input type="checkbox"/>	<input type="checkbox"/>	-	-	-	-	-

Save Reset Refresh << >>

Parameter description:

VLAN ID

The VLAN ID of the entry.

MLD Snooping Enabled

Enable the per-VLAN MLD Snooping. Only up to 64 VLANs can be selected.

MLD Querier

Enable the IGMP Querier in the VLAN.

RV

Robustness Variable. The Robustness Variable allows tuning for the expected packet loss on a link. The allowed range is 1 to 255, default robustness variable value is 2.

QI

Query Interval. The Query Interval variable denotes the interval between General Queries sent by the Querier. The allowed range is 1 to 255 seconds, default query interval is 125 seconds.

QRI

Query Response Interval. The Maximum Response Delay used to calculate the Maximum Response Code inserted into the periodic General Queries. The allowed range is 0 to 31744 in tenths of seconds, default query response interval is 100 in tenths of seconds (10 seconds).

LLQI

Last Listener Query Interval. The Last Listener Query Interval is the Maximum Response Delay used to calculate the Maximum Response Code inserted into Multicast Address Specific Queries sent in response to Version 1 Multicast Listener Done messages. It is also the Maximum Response Delay used to calculate the Maximum Response Code inserted into Multicast Address and Source Specific Query messages. The allowed range is 0 to 31744 in tenths of seconds, default last listener query interval is 10 in tenths of seconds (1 second).

URI

Unsolicited Report Interval. The Unsolicited Report Interval is the time between repetitions of a node's initial report of interest in a multicast address. The allowed range is 0 to 31744 seconds, default unsolicited report interval is 1 second.

2-6.3 Port Group Fitering

The section describes that you could to set the Port Group Filtering in the MLD Snooping function. On the UI that you could add new filtering group and safty policy.

Web Interface

To configure the MLD Snooping Port Group Configuration in the web interface:

1. Click Configuration, MLD Snooping, Port Group Filtering Configuration
2. Click the Add new Filtering Group
3. Specify the Filtering Groups with entries per page.
4. Click the save to save the setting
5. If you want to cancel the setting then you need to click the Reset button.
It will revert to previously saved values

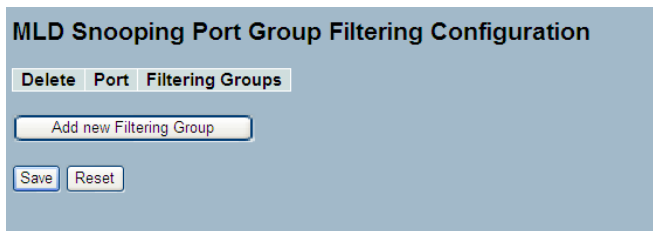

Parameter description:

Delete

Check to delete the entry. It will be deleted during the next save.

Port

The logical port for the settings.

Filtering Groups

The IP Multicast Group that will be filtered.

Adding New Filtering Group

2-6.4 Status

The section describes when you complete the MLD Snooping and how to display the MLD Snooping Status and detail information. It will help you to find out the detail information of MLD Snooping status.

Web Interface

To display the MLD Snooping Status in the web interface:

1. Click Configuration, MLD Snooping, Status
2. If you want to auto-refresh the information then you need to evoke the "Auto-refresh"
3. Click " Refresh" to refresh a entry of the MLD Snooping Status Information.
4. Click " Clear" to clear the MLD Snooping Status..

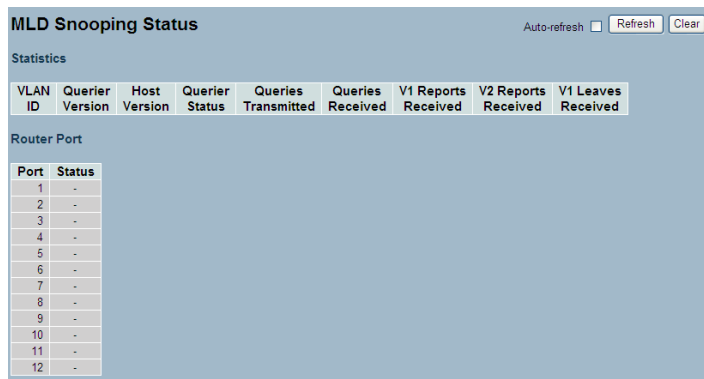

VLAN ID	Querier Version	Host Version	Querier Status	Queries Transmitted	Queries Received	V1 Reports Received	V2 Reports Received	V1 Leaves Received
Router Port								
Port	Status							
1	-							
2	-							
3	-							
4	-							
5	-							
6	-							
7	-							
8	-							
9	-							
10	-							
11	-							
12	-							

Parameter description:

VLAN ID

The VLAN ID of the entry.

Querier Version

Working Querier Version currently.

Host Version

Working Host Version currently.

Querier Status

Show the Querier status is "ACTIVE" or "IDLE".

Queries Transmitted

The number of Transmitted Queries.

Queries Received

The number of Received Queries.

V1 Reports Received

The number of Received V1 Reports.

V2 Reports Received

The number of Received V2 Reports.

V1 Leaves Received

The number of Received V1 Leaves.

2-6.5 Group Information

The section describes user could set the MLD Snooping Groups Information. The "Start from VLAN", and "group" input fields allow the user to select the starting point in the MLD Group Table

Each page shows up to 99 entries from the MLD Group table, default being 20, selected through the "entries per page" input field. When first visited, the web page will show the first 20 entries from the beginning of the MLD Group Table.

Web Interface

To display the MLD Snooping Group information in the web interface:

1. Click Configuration, MLD Snooping, Group Information
2. If you want to auto-refresh the information then you need to evoke the "Auto-refresh"
3. Click " Refresh" to refresh a entry of the MLD Snooping Group Information.
4. Click " Clear" to clear the MLD Snooping Groups information..

		Port Members											
VLAN ID	Groups	1	2	3	4	5	6	7	8	9	10	11	12
No more entries													

Parameter description:

Navigating the MLD Group Table

Each page shows up to 99 entries from the MLD Group table, default being 20, selected through the "entries per page" input field. When first visited, the web page will show the first 20 entries from the beginning of the MLD Group Table. The "Start from VLAN", and "group" input fields allow the user to select the starting point in the MLD Group Table. Clicking the button will update the displayed table starting from that or the next closest MLD Group Table match. In addition, the two input fields will - upon a button click - assume the value of the first displayed entry, allowing for continuous refresh with the same start address. The will use the last entry of the currently displayed as a basis for the next lookup. When the end is reached the text "No more entries" is shown in the displayed table. Use the button to start over.

2-6.6 IPv6 SSM Information

The section describes the user to configure the Entries in the MLDv2

Information Table are shown on this page. The MLDv2 Information Table is sorted first by VLAN ID, then by group, and then by Port No. Different source addresses belong to the same group are treated as single entry.

Each page shows up to 64 entries from the MLDv2 SSM (Source Specific Multicast) Information table, default being 20, selected through the "entries per page" input field. When first visited, the web page will show the first 20 entries from the beginning of the MLDv2 Information Table. The "Start from VLAN", and "group" input fields allow the user to select the starting point in the MLDv2 Information Table.

Web Interface

To display the MLDv2 IPv6 SSM Information in the web interface:

1. Click Configuration, MLD Snooping, IPv6 SSM Information
2. If you want to auto-refresh the information then you need to evoke the "Auto-refresh".
3. Click "Refresh" to refresh a entry of the MLDv2 IPv6 SSM Information.
4. Click "<< or >>" to move to previous or next entry.

VLAN ID	Group	Port No.	Mode	Source Address	Type
No more entries					

Parameter description:

MLDv2 Information Table Columns

VLAN ID

VLAN ID of the group.

Group

Group address of the group displayed.

Port

Switch port number.

Mode

Indicates the filtering mode maintained per (VLAN ID, port number, Group Address) basis. It can be either Include or Exclude.

Source Address

IP Address of the source. Currently, system limits the total number of IP

source addresses for filtering to be 128.

Type

Indicates the Type. It can be either Allow or Deny.

2-7 MVR

The MVR feature enables multicast traffic forwarding on the Multicast VLAN. In a multicast television application, a PC or a television with a set-top box can receive the multicast stream. Multiple set-top boxes or PCs can be connected to one subscriber port, which is a switch port configured as an MVR receiver port. When a subscriber selects a channel, the set-top box or PC sends an IGMP join message to Switch A to join the appropriate multicast. Uplink ports that send and receive multicast data to and from the multicast VLAN are called MVR source ports.

2-7.1 Configuration

The section describes user could set the MVR basic Configuration and some parameters in the switch

Web Interface

To configure the MLD Snooping Port Group Configuration in the web interface:

1. Click Configuration, MVR, Configuration
2. Scroll the MVR mode to enable or disable and Scroll to set all parameters.
3. Click the save to save the setting
4. If you want to cancel the setting then you need to click the Reset button. It will revert to previously saved values

MVR Configuration			
MVR Mode	Disabled		
VLAN ID	100		

Port Configuration			
Port	Mode	Type	Immediate Leave
1	Disabled	Receiver	Disabled
2	Disabled	Receiver	Disabled
3	Disabled	Receiver	Disabled
4	Disabled	Receiver	Disabled
5	Disabled	Receiver	Disabled
6	Disabled	Receiver	Disabled
7	Disabled	Receiver	Disabled
8	Disabled	Receiver	Disabled
9	Disabled	Receiver	Disabled
10	Disabled	Receiver	Disabled
11	Disabled	Receiver	Disabled
12	Disabled	Receiver	Disabled

Save Reset

Parameter description:

MVR Mode
Enable/Disable the Global MVR.

VLAN ID
Specify the Multicast VLAN ID.

Mode
Enable MVR on the port.

Type
Specify the MVR port type on the port.

Immediate Leave
Enable the fast leave on the port.

2-7.2 Groups Information

The section describes user could display the MVR Groups detail information on the switch. Entries in the MVR Group Table are shown on this page. The MVR Group Table is sorted first by VLAN ID, and then by group

Web Interface

To display the MVR Groups Information in the web interface:

1. Click Configuration, MVR, Groups Information
2. If you want to auto-refresh the information then you need to evoke the “Auto-refresh”.
3. To Click the “ Refresh “ to refresh a entry of the MVR Groups Information.
4. Click “<< or >> “ to move to previous or next entry.

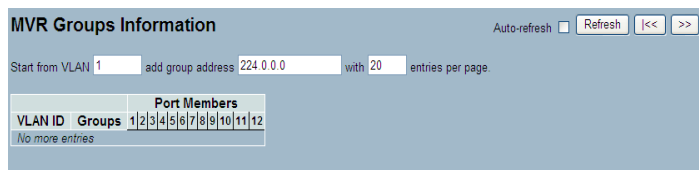

MVR Groups Information Auto-refresh Refresh << >>

Start from VLAN add group address with entries per page.

		Port Members											
VLAN ID	Groups	1	2	3	4	5	6	7	8	9	10	11	12
No more entries													

Parameter description:

MVR Group Table Columns

VLAN ID
VLAN ID of the group.

Groups
Group ID of the group displayed.

Port Members
Ports under this group.

2-7.3 Statistics

The section describes the switch will display the MVR detail Statistics after you had configured MVR on the switch. It provides the detail MVR Statistics Information

Web Interface

To display the MVR Statistics Information in the web interface:

1. Click Configuration, MVR, Statistics
2. If you want to auto-refresh the information then you need to evoke the “Auto-refresh”.
3. To Click the “ Refresh” to refresh a entry of the MVR Statistics Information.
4. Click “<< or >> “ to move to previous or next entry.



VLAN ID	V1 Reports Received	V2 Reports Received	V3 Reports Received	V2 Leaves Received
100	0	0	0	0

Parameter description:

VLAN ID
The Multicast VLAN ID.

V1 Reports Received
The number of Received V1 Reports.

V2 Reports Received
The number of Received V2 Reports.

V3 Reports Received
The number of Received V3 Reports.

V2 Leaves Received
The number of Received V2 Leaves.

2-8 LLDP

The switch supports the LLDP. For current information on your

switch model, The Link Layer Discovery Protocol (LLDP) provides a standards-based method for enabling switches to advertise themselves to adjacent devices and to learn about adjacent LLDP devices. The Link Layer Discovery Protocol (LLDP) is a vendor-neutral Link Layer protocol in the Internet Protocol Suite used by network devices for advertising their identity, capabilities, and neighbors on a IEEE 802 local area network, principally wired Ethernet. The protocol is formally referred to by the IEEE as Station and Media Access Control Connectivity Discovery specified in standards document IEEE 802.1AB.

2-8.1 LLDP Configuration

You can per port to do the LLDP configuration and the detail parameters, the settings will take effect immediately. This page allows the user to inspect and configure the current LLDP port settings.

Web Interface

To configure LLDP:

1. Click LLDP configuration
2. Modify LLDP timing parameters
3. Set the required mode for transmitting or receiving LLDP messages
4. Specify the information to include in the TLV field of advertised messages
5. Click Save

LLDP Configuration

LLDP Parameters

Tx Interval	<input type="text" value="30"/>	seconds
Tx Hold	<input type="text" value="3"/>	times
Tx Delay	<input type="text" value="2"/>	seconds
Tx Reinit	<input type="text" value="2"/>	seconds

Port	Mode	CDP aware	Optional TLVs				
			Port Descr	Sys Name	Sys Descr	Sys Capa	Mgmt Addr
1	Disabled	<input type="checkbox"/>	<input checked="" type="checkbox"/>	<input checked="" type="checkbox"/>	<input checked="" type="checkbox"/>	<input checked="" type="checkbox"/>	<input checked="" type="checkbox"/>
2	Disabled	<input type="checkbox"/>	<input checked="" type="checkbox"/>	<input checked="" type="checkbox"/>	<input checked="" type="checkbox"/>	<input checked="" type="checkbox"/>	<input checked="" type="checkbox"/>
3	Disabled	<input type="checkbox"/>	<input checked="" type="checkbox"/>	<input checked="" type="checkbox"/>	<input checked="" type="checkbox"/>	<input checked="" type="checkbox"/>	<input checked="" type="checkbox"/>
4	Disabled	<input type="checkbox"/>	<input checked="" type="checkbox"/>	<input checked="" type="checkbox"/>	<input checked="" type="checkbox"/>	<input checked="" type="checkbox"/>	<input checked="" type="checkbox"/>
5	Disabled	<input type="checkbox"/>	<input checked="" type="checkbox"/>	<input checked="" type="checkbox"/>	<input checked="" type="checkbox"/>	<input checked="" type="checkbox"/>	<input checked="" type="checkbox"/>
6	Disabled	<input type="checkbox"/>	<input checked="" type="checkbox"/>	<input checked="" type="checkbox"/>	<input checked="" type="checkbox"/>	<input checked="" type="checkbox"/>	<input checked="" type="checkbox"/>
7	Disabled	<input type="checkbox"/>	<input checked="" type="checkbox"/>	<input checked="" type="checkbox"/>	<input checked="" type="checkbox"/>	<input checked="" type="checkbox"/>	<input checked="" type="checkbox"/>
8	Disabled	<input type="checkbox"/>	<input checked="" type="checkbox"/>	<input checked="" type="checkbox"/>	<input checked="" type="checkbox"/>	<input checked="" type="checkbox"/>	<input checked="" type="checkbox"/>
9A	Disabled	<input type="checkbox"/>	<input checked="" type="checkbox"/>	<input checked="" type="checkbox"/>	<input checked="" type="checkbox"/>	<input checked="" type="checkbox"/>	<input checked="" type="checkbox"/>
10A	Disabled	<input type="checkbox"/>	<input checked="" type="checkbox"/>	<input checked="" type="checkbox"/>	<input checked="" type="checkbox"/>	<input checked="" type="checkbox"/>	<input checked="" type="checkbox"/>
9B	Disabled	<input type="checkbox"/>	<input checked="" type="checkbox"/>	<input checked="" type="checkbox"/>	<input checked="" type="checkbox"/>	<input checked="" type="checkbox"/>	<input checked="" type="checkbox"/>
10B	Disabled	<input type="checkbox"/>	<input checked="" type="checkbox"/>	<input checked="" type="checkbox"/>	<input checked="" type="checkbox"/>	<input checked="" type="checkbox"/>	<input checked="" type="checkbox"/>

Parameter description:

LLDP Parameters

Tx Interval

The switch periodically transmits LLDP frames to its neighbours for having the network discovery information up-to-date. The interval between each LLDP frame is determined by the Tx Interval value. Valid values are restricted to 5 - 32768 seconds.

Tx Hold

Each LLDP frame contains information about how long the information in the LLDP frame shall be considered valid. The LLDP information valid period is set to Tx Hold multiplied by Tx Interval seconds. Valid values are restricted to 2 - 10 times.

Tx Delay

If some configuration is changed (e.g. the IP address) a new LLDP frame is transmitted, but the time between the LLDP frames will always be at least the value of Tx Delay seconds. Tx Delay cannot be larger than 1/4 of the Tx Interval value. Valid values are restricted to 1 - 8192 seconds.

Tx Reinit

When a port is disabled, LLDP is disabled or the switch is rebooted, an LLDP shutdown frame is transmitted to the neighboring units, signalling that the LLDP information isn't valid anymore. Tx Reinit controls the amount of seconds between the shutdown frame and a new LLDP initialization. Valid values are restricted to 1 - 10 seconds.

LLDP Port Configuration

The LLDP port settings relate to the currently selected stack unit, as reflected by the page header.

Port

The switch port number of the logical LLDP port.

Mode

Select LLDP mode.

Rx only The switch will not send out LLDP information, but LLDP information from neighbour units is analyzed.

Tx only The switch will drop LLDP information received from neighbours, but will send out LLDP information.

Disabled The switch will not send out LLDP information, and will drop LLDP information received from neighbours.

Enabled The switch will send out LLDP information, and will analyze LLDP information received from neighbours.

CDP Aware

Select CDP awareness.

The CDP operation is restricted to decoding incoming CDP frames (The switch doesn't transmit CDP frames). CDP frames are only decoded if LLDP on the port is enabled.

Only CDP TLVs that can be mapped to a corresponding field in the LLDP neighbours' table are decoded. All other TLVs are discarded (Unrecognized CDP TLVs and discarded CDP frames are not shown in the LLDP statistics.). CDP TLVs are mapped onto LLDP neighbours' table as shown below.

CDP TLV "Device ID" is mapped to the LLDP "Chassis ID" field.

CDP TLV "Address" is mapped to the LLDP "Management Address" field.

The CDP address TLV can contain multiple addresses, but only the first address is shown in the LLDP neighbours table.

CDP TLV "Port ID" is mapped to the LLDP "Port ID" field.

CDP TLV "Version and Platform" is mapped to the LLDP "System Description" field.

Both the CDP and LLDP support "system capabilities", but the CDP capabilities cover capabilities that are not part of the LLDP. These capabilities are shown as "others" in the LLDP neighbours' table.

If all ports have CDP awareness disabled the switch forwards CDP frames received from neighbour devices. If at least one port has CDP awareness enabled all CDP frames are terminated by the switch.

Note: When CDP awareness on a port is disabled the CDP information isn't removed immediately, but gets when the hold time is exceeded.

Port Descr

Optional TLV: When checked the "port description" is included in LLDP information transmitted.

Sys Name

Optional TLV: When checked the "system name" is included in LLDP information transmitted.

Sys Descr

Optional TLV: When checked the "system description" is included in LLDP information transmitted.

Sys Capa

Optional TLV: When checked the "system capability" is included in LLDP information transmitted.

Mgmt Addr

Optional TLV: When checked the "management address" is included in LLDP information transmitted.

2-8.2 LLDP Neighbours

This page provides a status overview for all LLDP neighbours. The displayed table contains a row for each port on which an LLDP neighbour is detected. The columns hold the following information:

Web Interface

To show LLDP neighbours:

1. Click LLDP Neighbours
2. Click Refresh for manual update web screen
3. Click Auto-refresh for auto-update web screen

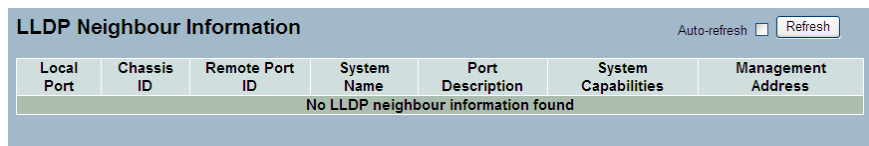

Local Port	Chassis ID	Remote Port ID	System Name	Port Description	System Capabilities	Management Address
No LLDP neighbour information found						

Parameter description:

Local Port

The port on which the LLDP frame was received.

Chassis ID

The Chassis ID is the identification of the neighbour's LLDP frames.

Remote Port ID

The Remote Port ID is the identification of the neighbour port.

System Name

System Name is the name advertised by the neighbour unit.

Port Description

Port Description is the port description advertised by the neighbour unit.

System Capabilities

System Capabilities describes the neighbour unit's capabilities. The possible capabilities are:

1. Other
2. Repeater
3. Bridge
4. WLAN Access Point
5. Router
6. Telephone
7. DOCSIS cable device
8. Station only
9. Reserved

When a capability is enabled, the capability is followed by (+). If the capability is disabled, the capability is followed by (-).

Management Address

Management Address is the neighbour unit's address that is used for higher layer entities to assist discovery by the network management. This could for instance hold the neighbour's IP address.

2-8.3 LLDP-MED Configuration

Media Endpoint Discovery is an enhancement of LLDP, known as LLDP-MED, that provides the following facilities:

Auto-discovery of LAN policies (such as VLAN, Layer 2 Priority and Differentiated services (Diffserv) settings) enabling plug and play networking.

Device location discovery to allow creation of location databases and, in the case of Voice over Internet Protocol (VoIP), Enhanced 911 services.

Extended and automated power management of Power over Ethernet (PoE) end points.

Inventory management, allowing network administrators to track their network devices, and determine their characteristics (manufacturer, software and hardware versions, serial or asset number).

This page allows you to configure the LLDP-MED. This function applies to VoIP devices which support LLDP-MED.

Web Interface

To configure LLDP-MED

:

1. Click LLDP-MED Configuration
2. Modify Fast start repeat count parameter, default is 4
3. Modify Coordinates Location parameters
4. Fill Civic Address Location parameters
5. Add new policy
6. Click Save, will show following Policy Port Configuration
7. Select Policy ID for each port
8. Click Save

LLDPMED Configuration

Fast Start Repeat Count

Fast start repeat count

Coordinates Location

Latitude degrees North Longitude degrees East Altitude Meters Map Datum WGS

Civic Address Location

Country code	<input type="text"/>	State	<input type="text"/>	County	<input type="text"/>
City	<input type="text"/>	City district	<input type="text"/>	Block (Neighbourhood)	<input type="text"/>
Street	<input type="text"/>	Leading street direction	<input type="text"/>	Trailing street suffix	<input type="text"/>
Street suffix	<input type="text"/>	House no.	<input type="text"/>	House no. suffix	<input type="text"/>
Landmark	<input type="text"/>	Additional location info	<input type="text"/>	Name	<input type="text"/>

Civic Address Location

Country code	<input type="text"/>	State	<input type="text"/>	County	<input type="text"/>
City	<input type="text"/>	City district	<input type="text"/>	Block (Neighbourhood)	<input type="text"/>
Street	<input type="text"/>	Leading street direction	<input type="text"/>	Trailing street suffix	<input type="text"/>
Street suffix	<input type="text"/>	House no.	<input type="text"/>	House no. suffix	<input type="text"/>
Landmark	<input type="text"/>	Additional location info	<input type="text"/>	Name	<input type="text"/>
Zip code	<input type="text"/>	Building	<input type="text"/>	Apartment	<input type="text"/>
Floor	<input type="text"/>	Room no.	<input type="text"/>	Place type	<input type="text"/>
Postal community name	<input type="text"/>	P.O. Box	<input type="text"/>	Additional code	<input type="text"/>

Emergency Call Service

Emergency Call Service

Policies

Delete	Policy ID	Application Type	Tag	VLAN ID	L2 Priority	DSCP
Delete	0	Voice	Tagged	1	0	0
Delete	1	Voice	Tagged	1	0	0
Delete	2	Voice	Tagged	1	0	0

Add new policy

Policy Port Configuration

Save Reset

Policy Port Configuration

Port	Policy ID		
	0	1	2
1	<input type="checkbox"/>	<input checked="" type="checkbox"/>	<input type="checkbox"/>
2	<input type="checkbox"/>	<input checked="" type="checkbox"/>	<input type="checkbox"/>
3	<input checked="" type="checkbox"/>	<input type="checkbox"/>	<input type="checkbox"/>
4	<input checked="" type="checkbox"/>	<input type="checkbox"/>	<input type="checkbox"/>
5	<input type="checkbox"/>	<input type="checkbox"/>	<input checked="" type="checkbox"/>
6	<input type="checkbox"/>	<input type="checkbox"/>	<input checked="" type="checkbox"/>
7	<input checked="" type="checkbox"/>	<input checked="" type="checkbox"/>	<input type="checkbox"/>
8	<input checked="" type="checkbox"/>	<input checked="" type="checkbox"/>	<input type="checkbox"/>
9	<input type="checkbox"/>	<input checked="" type="checkbox"/>	<input checked="" type="checkbox"/>
10	<input type="checkbox"/>	<input checked="" type="checkbox"/>	<input checked="" type="checkbox"/>

Save Reset

Parameter description:

Fast start repeat count

Rapid startup and Emergency Call Service Location Identification Discovery of endpoints is a critically important aspect of VoIP systems in general. In addition, it is best to advertise only those pieces of information which are specifically relevant to particular endpoint types (for example only advertise the voice network policy to permitted voice-capable devices), both in order to conserve the limited LLDPDU space and to reduce security and system integrity issues that can come with inappropriate knowledge of the network policy.

With this in mind LLDP-MED defines an LLDP-MED Fast Start interaction between the protocol and the application layers on top of the protocol, in order to achieve these related properties. Initially, a Network Connectivity Device will only transmit LLDP TLVs in an LLDPDU. Only after an LLDP-MED Endpoint Device is detected, will an LLDP-MED capable Network Connectivity Device start to advertise LLDP-MED TLVs in outgoing LLDPDUs on the associated port. The LLDP-MED application will temporarily speed up the transmission of the LLDPDU to start within a second, when a new LLDP-MED neighbour has been detected in order to share LLDP-MED information as fast as possible to new neighbours.

Because there is a risk of an LLDP frame being lost during transmission between neighbours, it is recommended to repeat the fast start transmission multiple times to increase the possibility of the neighbours receiving the LLDP frame. With Fast start repeat count it is possible to specify the number of times the fast start transmission would be repeated. The recommended value is 4 times, given that 4 LLDP frames with a 1 second interval will be transmitted, when an LLDP frame with new information is received.

It should be noted that LLDP-MED and the LLDP-MED Fast Start mechanism is only intended to run on links between LLDP-MED Network Connectivity Devices and Endpoint Devices, and as such does not apply to links between LAN infrastructure elements, including Network Connectivity Devices, or other types of links.

Coordinates Location

Latitude

Latitude SHOULD be normalized to within 0-90 degrees with a maximum of 4 digits.

It is possible to specify the direction to either North of the equator or South of the equator.

Longitude

Longitude SHOULD be normalized to within 0-180 degrees with a maximum of 4 digits.

It is possible to specify the direction to either East of the prime meridian or West of the prime meridian.

Altitude

Altitude SHOULD be normalized to within -32767 to 32767 with a maximum of 4 digits.

It is possible to select between two altitude types (floors or meters).
Meters: Representing meters of Altitude defined by the vertical datum specified.

Floors: Representing altitude in a form more relevant in buildings which have different floor-to-floor dimensions. An altitude = 0.0 is meaningful even outside a building, and represents ground level at the given latitude and longitude. Inside a building, 0.0 represents the floor level associated with ground level at the main entrance.

Map Datum

The Map Datum is used for the coordinates given in these options:

WGS84: (Geographical 3D) - World Geodesic System 1984, CRS Code 4327, Prime Meridian Name: Greenwich.

NAD83/NAVD88: North American Datum 1983, CRS Code 4269, Prime Meridian Name: Greenwich; The associated vertical datum is the North American Vertical Datum of 1988 (NAVD88). This datum pair is to be used when referencing locations on land, not near tidal water (which would use Datum = NAD83/MLLW).

NAD83/MLLW: North American Datum 1983, CRS Code 4269, Prime Meridian Name: Greenwich; The associated vertical datum is Mean Lower Low Water (MLLW). This datum pair is to be used when referencing locations on water/sea/ocean.

Civic Address Location

IETF Geopriv Civic Address based Location Configuration Information (Civic Address LCI).

Country code

The two-letter ISO 3166 country code in capital ASCII letters - Example: DK, DE or US.

State

National subdivisions (state, canton, region, province, prefecture).

County

County, parish, gun (Japan), district.

City

City, township, shi (Japan) - Example: Copenhagen.

City district

City division, borough, city district, ward, chou (Japan).

Block (Neighbourhood)

Neighbourhood, block.

Street

Street - Example: Poppelvej.

Leading street direction

Leading street direction - Example: N.

Trailing street suffix

Trailing street suffix - Example: SW.

Street suffix

Street suffix - Example: Ave, Platz.

House no.

House number - Example: 21.

House no. suffix

House number suffix - Example: A, 1/2.

Landmark

Landmark or vanity address - Example: Columbia University.

Additional location info

Additional location info - Example: South Wing.

Name

Name (residence and office occupant) - Example: Flemming Jahn.

Zip code

Postal/zip code - Example: 2791.

Building

Building (structure) - Example: Low Library.

Apartment

Unit (Apartment, suite) - Example: Apt 42.

Floor

Floor - Example: 4.

Room no.

Room number - Example: 450F.

Place type

Place type - Example: Office.

Postal community name

Postal community name - Example: Leonia.

P.O. Box

Post office box (P.O. BOX) - Example: 12345.

Additional code

Additional code - Example: 1320300003.

Emergency Call Service

Emergency Call Service (e.g. E911 and others), such as defined by TIA or NENA.

Emergency Call Service

Emergency Call Service ELIN identifier data format is defined to carry the ELIN identifier as used during emergency call setup to a traditional CAMA or ISDN trunk-based PSAP. This format consists of a numerical digit string, corresponding to the ELIN to be used for emergency calling.

Policies

Network Policy Discovery enables the efficient discovery and diagnosis of mismatch issues with the VLAN configuration, along with the associated Layer 2 and Layer 3 attributes, which apply for a set of specific protocol applications on that port. Improper network policy configurations are a very significant issue in VoIP environments that frequently result in voice quality degradation or loss of service.

Policies are only intended for use with applications that have specific 'real-time' network policy requirements, such as interactive voice and/or video services.

The network policy attributes advertised are:

1. Layer 2 VLAN ID (IEEE 802.1Q-2003)
2. Layer 2 priority value (IEEE 802.1D-2004)
3. Layer 3 Diffserv code point (DSCP) value (IETF RFC 2474)

This network policy is potentially advertised and associated with multiple sets of application types supported on a given port. The application types specifically addressed are:

1. Voice
2. Guest Voice
3. Softphone Voice
4. Video Conferencing
5. Streaming Video

6. Control / Signalling (conditionally support a separate network policy for the media types above)

A large network may support multiple VoIP policies across the entire organization, and different policies per application type. LLDP-MED allows multiple policies to be advertised per port, each corresponding to a different application type. Different ports on the same Network Connectivity Device may advertise different sets of policies, based on the authenticated user identity or port configuration.

It should be noted that LLDP-MED is not intended to run on links other than between Network Connectivity Devices and Endpoints, and therefore does not need to advertise the multitude of network policies that frequently run on an aggregated link interior to the LAN.

Delete

Check to delete the policy. It will be deleted during the next save.

Policy ID

ID for the policy. This is auto generated and shall be used when selecting the polices that shall be mapped to the specific ports.

Application Type

Intended use of the application types:

1. Voice - for use by dedicated IP Telephony handsets and other similar appliances supporting interactive voice services. These devices are typically deployed on a separate VLAN for ease of deployment and enhanced security by isolation from data applications.
2. Voice Signalling (conditional) - for use in network topologies that require a different policy for the voice signalling than for the voice media. This application type should not be advertised if all the same network policies apply as those advertised in the Voice application policy.
3. Guest Voice - support a separate 'limited feature-set' voice service for guest users and visitors with their own IP Telephony handsets and other similar appliances supporting interactive voice services.
4. Guest Voice Signalling (conditional) - for use in network topologies that require a different policy for the guest voice signalling than for the guest voice media. This application type should not be advertised if all the same network policies apply as those advertised in the Guest Voice application policy.
5. Softphone Voice - for use by softphone applications on typical data centric devices, such as PCs or laptops. This class of endpoints frequently does not support multiple VLANs, if at all, and are typically configured to use an 'untagged' VLAN or a single 'tagged' data specific VLAN. When a

network policy is defined for use with an 'untagged' VLAN (see Tagged flag below), then the L2 priority field is ignored and only the DSCP value has relevance.

6. Video Conferencing - for use by dedicated Video Conferencing equipment and other similar appliances supporting real-time interactive video/audio services.

7. Streaming Video - for use by broadcast or multicast based video content distribution and other similar applications supporting streaming video services that require specific network policy treatment. Video applications relying on TCP with buffering would not be an intended use of this application type.

8. Video Signalling (conditional) - for use in network topologies that require a separate policy for the video signalling than for the video media. This application type should not be advertised if all the same network policies apply as those advertised in the Video Conferencing application policy.

Tag

Tag indicating whether the specified application type is using a 'tagged' or an 'untagged' VLAN.

Untagged indicates that the device is using an untagged frame format and as such does not include a tag header as defined by IEEE 802.1Q-2003. In this case, both the VLAN ID and the Layer 2 priority fields are ignored and only the DSCP value has relevance.

Tagged indicates that the device is using the IEEE 802.1Q tagged frame format, and that both the VLAN ID and the Layer 2 priority values are being used, as well as the DSCP value. The tagged format includes an additional field, known as the tag header. The tagged frame format also includes priority tagged frames as defined by IEEE 802.1Q-2003.

VLAN ID

VLAN identifier (VID) for the port as defined in IEEE 802.1Q-2003.

L2 Priority

L2 Priority is the Layer 2 priority to be used for the specified application type. L2 Priority may specify one of eight priority levels (0 through 7), as defined by IEEE 802.1D-2004. A value of 0 represents use of the default priority as defined in IEEE 802.1D-2004.

DSCP

DSCP value to be used to provide Diffserv node behaviour for the specified application type as defined in IETF RFC 2474. DSCP may contain one of 64 code point values (0 through 63). A value of 0 represents use of the default DSCP value as defined in RFC 2475.

Adding a new policy

Click to add a new policy. Specify the Application type, Tag, VLAN ID, L2 Priority and DSCP for the new policy. Click "Save".

Port Policies Configuration

Every port may advertise a unique set of network policies or different attributes for the same network policies, based on the authenticated user identity or port configuration.

Port

The port number to which the configuration applies.

Policy Id

The set of policies that shall apply to a given port. The set of policies is selected by check marking the checkboxes that corresponds to the policies.

2-8.4 LLDP-MED Neighbours

This page provides a status overview of all LLDP-MED neighbours. The displayed table contains a row for each port on which an LLDP neighbour is detected. This function applies to VoIP devices which support LLDP-MED. The columns hold the following information:

Web Interface

To show LLDP-MED neighbours:

1. Click LLDP-MED Neighbours
2. Click Refresh for manual update web screen
3. Click Auto-refresh for auto-update web screen



Parameter description:

Port

The port on which the LLDP frame was received.

Device Type

LLDP-MED Devices are comprised of two primary Device Types: Network Connectivity Devices and Endpoint Devices.

LLDP-MED Network Connectivity Device Definition

LLDP-MED Network Connectivity Devices, as defined in TIA-1057, provide access to the IEEE 802 based LAN infrastructure for LLDP-MED Endpoint Devices. An LLDP-MED Network Connectivity Device is a LAN access device based on any of the following technologies:

1. LAN Switch/Router
2. IEEE 802.1 Bridge
3. IEEE 802.3 Repeater (included for historical reasons)
4. IEEE 802.11 Wireless Access Point
5. Any device that supports the IEEE 802.1AB and MED extensions defined by TIA-1057 and can relay IEEE 802 frames via any method.

LLDP-MED Endpoint Device Definition

LLDP-MED Endpoint Devices, as defined in TIA-1057, are located at the IEEE 802 LAN network edge, and participate in IP communication service using the LLDP-MED framework.

Within the LLDP-MED Endpoint Device category, the LLDP-MED scheme is broken into further Endpoint Device Classes, as defined in the following.

Each LLDP-MED Endpoint Device Class is defined to build upon the capabilities defined for the previous Endpoint Device Class. For-example will any LLDP-MED Endpoint Device claiming compliance as a Media Endpoint (Class II) also support all aspects of TIA-1057 applicable to Generic Endpoints (Class I), and any LLDP-MED Endpoint Device claiming compliance as a Communication Device (Class III) will also support all aspects of TIA-1057 applicable to both Media Endpoints (Class II) and Generic Endpoints (Class I).

LLDP-MED Generic Endpoint (Class I)

The LLDP-MED Generic Endpoint (Class I) definition is applicable to all endpoint products that require the base LLDP discovery services defined in TIA-1057, however do not support IP media or act as an end-user communication appliance. Such devices may include (but are not limited to) IP Communication Controllers, other communication related servers, or any device requiring basic services as defined in TIA-1057.

Discovery services defined in this class include LAN configuration, device location, network policy, power management, and inventory management.

LLDP-MED Media Endpoint (Class II)

The LLDP-MED Media Endpoint (Class II) definition is applicable to all endpoint products that have IP media capabilities however may or may not be associated with a particular end user. Capabilities include all of the capabilities defined for the previous Generic Endpoint Class (Class I), and are extended to include aspects related to media streaming. Example product categories expected to adhere to this class include (but are not limited to) Voice / Media Gateways, Conference Bridges, Media Servers, and similar.

Discovery services defined in this class include media-type-specific network layer policy discovery.

LLDP-MED Communication Endpoint (Class III)

The LLDP-MED Communication Endpoint (Class III) definition is applicable to all endpoint products that act as end user communication appliances supporting IP media. Capabilities include all of the capabilities defined for the previous Generic Endpoint (Class I) and Media Endpoint (Class II) classes, and are extended to include aspects related to end user devices. Example product categories expected to adhere to this class include (but are not limited to) end user communication appliances, such as IP Phones, PC-based softphones, or other communication appliances that directly support the end user.

Discovery services defined in this class include provision of location identifier (including ECS / E911 information), embedded L2 switch support, inventory management.

LLDP-MED Capabilities

LLDP-MED Capabilities describes the neighbour unit's LLDP-MED capabilities. The possible capabilities are:

1. LLDP-MED capabilities
2. Network Policy
3. Location Identification
4. Extended Power via MDI - PSE
5. Extended Power via MDI - PD
6. Inventory
7. Reserved

Application Type

Application Type indicating the primary function of the application(s) defined for this network policy, advertised by an Endpoint or Network Connectivity Device. The possible application types are shown below.

1. Voice - for use by dedicated IP Telephony handsets and other similar appliances supporting interactive voice services. These devices are typically deployed on a separate VLAN for ease of deployment and enhanced security by isolation from data applications.
2. Voice Signalling - for use in network topologies that require a different policy for the voice signalling than for the voice media.

3. Guest Voice - to support a separate limited feature-set voice service for guest users and visitors with their own IP Telephony handsets and other similar appliances supporting interactive voice services.
4. Guest Voice Signalling - for use in network topologies that require a different policy for the guest voice signalling than for the guest voice media.
5. Softphone Voice - for use by softphone applications on typical data centric devices, such as PCs or laptops.
6. Video Conferencing - for use by dedicated Video Conferencing equipment and other similar appliances supporting real-time interactive video/audio services.
7. Streaming Video - for use by broadcast or multicast based video content distribution and other similar applications supporting streaming video services that require specific network policy treatment. Video applications relying on TCP with buffering would not be an intended use of this application type.
8. Video Signalling - for use in network topologies that require a separate policy for the video signalling than for the video media.

Policy

Policy indicates that an Endpoint Device wants to explicitly advertise that the policy is required by the device. Can be either Defined or Unknown

Unknown: The network policy for the specified application type is currently unknown.

Defined: The network policy is defined.

TAG

TAG is indicative of whether the specified application type is using a tagged or an untagged VLAN. Can be Tagged or Untagged.

Untagged: The device is using an untagged frame format and as such does not include a tag header as defined by IEEE 802.1Q-2003.

Tagged: The device is using the IEEE 802.1Q tagged frame format.

VLAN ID

VLAN ID is the VLAN identifier (VID) for the port as defined in IEEE 802.1Q-2003. A value of 1 through 4094 is used to define a valid VLAN ID. A value of 0 (Priority Tagged) is used if the device is using priority tagged frames as defined by IEEE 802.1Q-2003, meaning that only the IEEE 802.1D priority level is significant and the default PVID of the ingress port is used instead.

Priority

Priority is the Layer 2 priority to be used for the specified application type. One of the eight priority levels (0 through 7).

DSCP

DSCP is the DSCP value to be used to provide Diffserv node behavior for the specified application type as defined in IETF RFC 2474. Contain one of 64 code point values (0 through 63).

2-8.5 EEE

By using EEE power savings can be achieved at the expense of traffic latency. This latency occurs due to that the circuits EEE turn off to save power, need time to boot up before sending traffic over the link. This time is called "wake up time". To achieve minimal latency, devices can use LLDP to exchange information about their respective tx and rx "wake up time ", as a way to agree upon the minimum wake up time they need.

This page provides an overview of EEE information exchanged by LLDP.

Web Interface

To show LLDP EEE neighbours:

1. Click LLDP, than click EEE to show discovered EEE devices
2. Click Refresh for manual update web screen
3. Click Auto-refresh for auto-update web screen

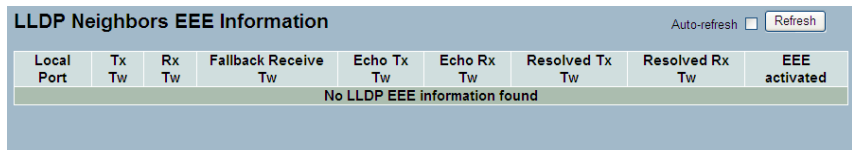

Local Port	Tx Tw	Rx Tw	Fallback Receive Tw	Echo Tx Tw	Echo Rx Tw	Resolved Tx Tw	Resolved Rx Tw	EEE activated
No LLDP EEE information found								

Parameter description:

Local Port

The port on which LLDP frames are received or transmitted.

Tx Tw

The link partner's maximum time that transmit path can hold off sending data after deassertion of LPI.

Rx Tw

The link partner's time that receiver would like the transmitter to hold off to allow time for the receiver to wake from sleep.

Fallback Receive Tw

The link partner's fallback receive Tw.

A receiving link partner may inform the transmitter of an alternate desired Tw_sys_tx. Since a receiving link partner is likely to have discrete levels for savings, this provides the transmitter with additional information that it may use for a more efficient allocation. Systems that do not implement this option default the value to be the same as that of the Receive Tw_sys_tx.

Echo Tx Tw

The link partner's Echo Tx Tw value.

The respective echo values shall be defined as the local link partners reflection (echo) of the remote link partners respective values. When a local link partner receives its echoed values from the remote link partner it can determine whether or not the remote link partner has received, registered and processed its most recent values. For example, if the local link partner receives echoed parameters that do not match the values in its local MIB, then the local link partner infers that the remote link partners request was based on stale information.

Echo Rx Tw

The link partner's Echo Rx Tw value.

Resolved Tx Tw

The resolved Tx Tw for this link. Note : NOT the link partner

The resolved value that is the actual "tx wakeup time " used for this link (based on EEE information exchanged via LLDP).

Resolved Rx Tw

The resolved Rx Tw for this link. Note : NOT the link partner

The resolved value that is the actual "tx wakeup time " used for this link (based on EEE information exchanged via LLDP).

2-8.6 Port Statistics

Two types of counters are shown. Global counters are counters that refer to the whole stack, switch, while local counters refer to per port counters for the currently selected switch

Web Interface

To show LLDP Statistics:

1. Click LLDP, then click Port Statistics to show LLDP counters
2. Click Refresh for manual update web screen
3. Click Auto-refresh for auto-update web screen
4. Click Clear to clear all counters

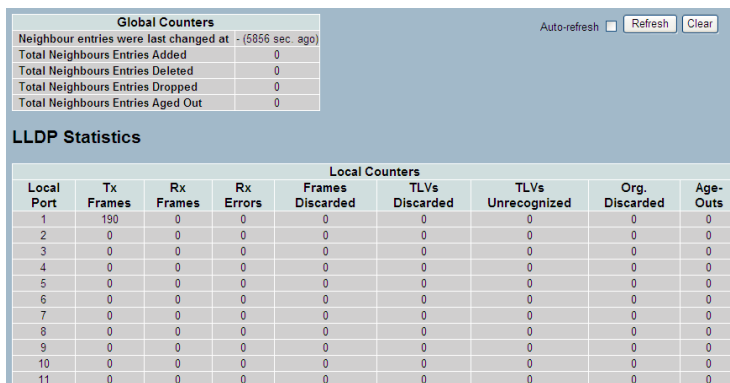

The screenshot displays the LLDP Statistics web interface. It is divided into two main sections: Global Counters and LLDP Statistics. The Global Counters section includes a table with four rows of statistics and their values, along with a timestamp and control buttons. The LLDP Statistics section features a table with columns for Local Port, Tx Frames, Rx Frames, Rx Errors, Local Counters (Frames Discarded, TLVs Discarded, TLVs Unrecognized, Org. Discarded, and Age-Outs), and values for each of the 11 ports.

Global Counters			
Neighbour entries were last changed at - (5856 sec. ago)			
Total Neighbours Entries Added	0		
Total Neighbours Entries Deleted	0		
Total Neighbours Entries Dropped	0		
Total Neighbours Entries Aged Out	0		

Auto-refresh Refresh Clear

LLDP Statistics

Local Port	Tx Frames	Rx Frames	Rx Errors	Local Counters				
				Frames Discarded	TLVs Discarded	TLVs Unrecognized	Org. Discarded	Age-Outs
1	190	0	0	0	0	0	0	0
2	0	0	0	0	0	0	0	0
3	0	0	0	0	0	0	0	0
4	0	0	0	0	0	0	0	0
5	0	0	0	0	0	0	0	0
6	0	0	0	0	0	0	0	0
7	0	0	0	0	0	0	0	0
8	0	0	0	0	0	0	0	0
9	0	0	0	0	0	0	0	0
10	0	0	0	0	0	0	0	0
11	0	0	0	0	0	0	0	0

Parameter description:

Global Counters

Neighbour entries were last changed on

It also shows the time when the last entry was last deleted or added. It also shows the time elapsed since the last change was detected.

Total Neighbours Entries Added

Shows the number of new entries added since switch reboot.

Total Neighbours Entries Deleted

Shows the number of new entries deleted since switch reboot.

Total Neighbours Entries Dropped

Shows the number of LLDP frames dropped due to the entry table being full.

Total Neighbours Entries Aged Out

Shows the number of entries deleted due to Time-To-Live expiring.

Local Counters

The displayed table contains a row for each port. The columns hold the following information:

Local Port

The port on which LLDP frames are received or transmitted.

Tx Frames

The number of LLDP frames transmitted on the port.

Rx Frames

The number of LLDP frames received on the port.

Rx Errors

The number of received LLDP frames containing some kind of error.

Frames Discarded

If an LLDP frame is received on a port, and the switch's internal table has run full, the LLDP frame is counted and discarded. This situation is known as "Too Many Neighbours" in the LLDP standard. LLDP frames require a new entry in the table when the Chassis ID or Remote Port ID is not already contained within the table. Entries are removed from the table when a given port's link is down, an LLDP shutdown frame is received, or when the entry ages out.

TLVs Discarded

Each LLDP frame can contain multiple pieces of information, known as TLVs (TLV is short for "Type Length Value"). If a TLV is malformed, it is counted and discarded.

TLVs Unrecognized

The number of well-formed TLVs, but with an unknown type value.

Org. Discarded

The number of organizationally received TLVs.

Age-Outs

Each LLDP frame contains information about how long time the LLDP information is valid (age-out time). If no new LLDP frame is received within the age out time, the LLDP information is removed, and the Age-Out counter is incremented.

2-9 Fitering Data Base

Fitering Data Base Configuration gathers many functions, including MAC Table Information, Static MAC Learning , which cannot be categorized to some function type.

MAC table

Switching of frames is based upon the DMAC address contained in the frame. The switch builds up a table that maps MAC addresses to switch ports for knowing which ports the frames should go to (based upon the DMAC address in the frame). This table contains both static and dynamic entries. The static entries are configured by the network administrator if the administrator wants to do a fixed mapping between the DMAC address and switch ports.

The frames also contain a MAC address (SMAC address), which shows the MAC address of the equipment sending the frame. The SMAC address is used by the switch to automatically update the MAC table with these dynamic MAC addresses. Dynamic entries are removed from the MAC table if no frame with the corresponding SMAC address have been seen after a configurable age time

2-9.1 Configuration

The MAC Address Table is configured on this page. Set timeouts for entries in the dynamic MAC Table and configure the static MAC table here.

Web Interface

To configure MAC Address Table in the web interface:

Aging Configuration

1. Click configuration .
2. Specify the Disable Automatic Aging and Aging Time.
3. Click Save.

MAC Table Learning

1. Click configuration .
2. Specify the Port Members(Auto,Disable,Secure).
3. Click Save.

Static MAC Table Configuration

1. Click configuration and Add new Static entry .
2. Specify the VLAN IP and Mac address ,Port Members.
3. Click Save.

MAC Address Table Configuration

Aging Configuration

Disable Automatic Aging

Aging Time seconds

MAC Table Learning

	Port Members											
	1	2	3	4	5	6	7	8	9A	10A	9B	10B
Auto	<input checked="" type="radio"/>	<input checked="" type="radio"/>	<input checked="" type="radio"/>	<input checked="" type="radio"/>	<input checked="" type="radio"/>	<input checked="" type="radio"/>	<input checked="" type="radio"/>	<input checked="" type="radio"/>	<input checked="" type="radio"/>	<input checked="" type="radio"/>	<input checked="" type="radio"/>	<input checked="" type="radio"/>
Disable	<input type="radio"/>	<input type="radio"/>	<input type="radio"/>	<input type="radio"/>	<input type="radio"/>	<input type="radio"/>	<input type="radio"/>	<input type="radio"/>	<input type="radio"/>	<input type="radio"/>	<input type="radio"/>	<input type="radio"/>
Secure	<input type="radio"/>	<input type="radio"/>	<input type="radio"/>	<input checked="" type="radio"/>	<input type="radio"/>	<input type="radio"/>	<input type="radio"/>	<input type="radio"/>	<input type="radio"/>	<input type="radio"/>	<input type="radio"/>	<input type="radio"/>

Static MAC Table Configuration

Delete	VLAN ID	MAC Address	Port Members											
			1	2	3	4	5	6	7	8	9A	10A	9B	10B
<input type="text"/>	<input type="text"/>	<input type="text"/>	<input type="radio"/>	<input type="radio"/>	<input type="radio"/>	<input type="radio"/>	<input type="radio"/>	<input type="radio"/>	<input type="radio"/>	<input type="radio"/>	<input type="radio"/>	<input type="radio"/>	<input type="radio"/>	<input type="radio"/>

Parameter description:

Aging Configuration

By default, dynamic entries are removed from the MAC table after 300 seconds. This removal is also called aging.

Configure aging time by entering a value here in seconds; for example, Age time seconds.

The allowed range is 10 to 1000000 seconds.

Disable the automatic aging of dynamic entries by checking Disable automatic aging.

MAC Table Learning

If the learning mode for a given port is greyed out, another module is in control of the mode, so that it cannot be changed by the user. An example of such a module is the MAC-Based Authentication under 802.1X.

Each port can do learning based upon the following settings:

Auto

Learning is done automatically as soon as a frame with unknown SMAC is received.

Disable

No learning is done.

Secure

Only static MAC entries are learned, all other frames are dropped.

Note: Make sure that the link used for managing the switch is added to the Static Mac Table before changing to secure learning mode, otherwise the management link is lost and can only be restored by using another non-secure port or by connecting to the switch via the serial interface.

Static MAC Table Configuration

The static entries in the MAC table are shown in this table. The static MAC table can contain 64 entries.

The maximum of 64 entries is for the whole stack, and not per switch.

The MAC table is sorted first by VLAN ID and then by MAC address.

Delete

Check to delete the entry. It will be deleted during the next save.

VLAN ID

The VLAN ID of the entry.

MAC Address

The MAC address of the entry.

Port Members

Checkmarks indicate which ports are members of the entry. Check or uncheck as needed to modify the entry.

Adding a New Static Entry

Click to add a new entry to the static MAC table. Specify the VLAN ID, MAC address, and port members for the new entry. Click "Save".

2-9.2 Status

Entries in the MAC Table are shown on this page. The MAC Table contains up to 8192 entries, and is sorted first by VLAN ID, then by MAC address.

Web Interface

To Display MAC Address Table in the web interface:

1. Click Dynamic MAC Table .
2. Specify the VLAN and MAC Address.
3. Display MAC Address Table.

MAC Address Table

Auto-refresh Refresh Clear << >>

Start from VLAN and MAC address with entries per page.

Type	VLAN	MAC Address	CPU	Port Members															
				1	2	3	4	5	6	7	8	9	10	11	12				
Static	1	00-01-C1-00-00-00	✓																
Dynamic	1	00-25-22-1C-70-F5		✓															
Static	1	33-33-FF-00-02-01																	
Static	1	33-33-FF-AB-C0-E2		✓															
Static	1	FF-FF-FF-FF-FF-FF	✓	✓	✓	✓	✓	✓	✓	✓	✓	✓	✓	✓	✓	✓	✓	✓	✓

Parameter description:

MAC Table Columns

Switch (stack only)

The stack unit where the entry is learned.

Type

Indicates whether the entry is a static or a dynamic entry.

MAC address

The MAC address of the entry.

VLAN

The VLAN ID of the entry.

Port Members

The ports that are members of the entry.

2-10 VLAN

To assign a specific VLAN for management purpose. The management VLAN is used to establish an IP connection to the switch from a workstation connected to a port in the VLAN. This connection supports a VSM, SNMP, and Telnet session. By default, the active management VLAN is VLAN 1, but you can designate any VLAN as the management VLAN using the Management VLAN window. Only one management VLAN can be active at a time.

When you specify a new management VLAN, your HTTP connection to the old management VLAN is lost. For this reason, you should have a connection between your management station and a port in the new management VLAN or connect to the new management VLAN through a multi-VLAN route

2-10.1 VLAN Membership

The VLAN membership configuration for the selected stack switch unit switch can be monitored and modified here. Up to 4096 VLANs are supported. This page allows for adding and deleting VLANs as well as adding and deleting port members of each VLAN.

Web Interface

To configure VLAN membership configuration in the web interface:

1. Click VLAN membership Configuration.
2. Specify Management VLAN ID. 0~ 4094
3. Click Save.

Delete	VLAN ID	VLAN Name	Port Members											
			1	2	3	4	5	6	7	8	9	10	11	12
<input type="checkbox"/>	1	default	<input checked="" type="checkbox"/>	<input checked="" type="checkbox"/>	<input checked="" type="checkbox"/>	<input checked="" type="checkbox"/>	<input checked="" type="checkbox"/>	<input checked="" type="checkbox"/>	<input checked="" type="checkbox"/>	<input checked="" type="checkbox"/>	<input checked="" type="checkbox"/>	<input checked="" type="checkbox"/>	<input checked="" type="checkbox"/>	<input checked="" type="checkbox"/>

Parameter description:

Delete

To delete a VLAN entry, check this box. The entry will be deleted on the selected switch in the stack. If none of the ports of this switch are members of a VLAN then the delete checkbox will be greyed out (you cannot delete that entry. during the next Save.

VLAN ID

Indicates the ID of this particular VLAN.

VLAN Name

Indicates the name of VLAN. VLAN Name can only contain alphabets or numbers. VLAN name should contain atleast one alphabet. VLAN name can be edited for the existing VLAN entries or it can be added to the new entries.

Port Members

A row of check boxes for each port is displayed for each VLAN ID. To include a port in a VLAN, check the box. To remove or exclude the port from the VLAN, make sure the box is unchecked. By default, no ports are members, and all boxes are unchecked.

Adding a New VLAN

Click to add a new VLAN ID. An empty row is added to the table, and the VLAN can be configured as needed. Legal values for a VLAN ID are 1 through 4095.

The VLAN is enabled on the selected stack switch unit when you click on "Save". The VLAN is thereafter present on the other stack switch units, but with no port members. The check box is greyed out when VLAN is displayed on other stacked switches, but user can add member ports to it. A VLAN without any port members on any stack unit will be deleted when you click "Save".

The button can be used to undo the addition of new VLANs.

2-10.2 Ports

The function in VLAN Tag Rule Setting, user can input VID number to each port. The range of VID number is from 1 to 4094. User also can choose ingress filtering rules to each port. There are two ingress filtering rules which can be applied to the switch. The Ingress Filtering Rule 1 is “forward only packets with VID matching this port’s configured VID”. The Ingress Filtering Rule 2 is “drop untagged frame”. You can also select the Role of each port as Access, Trunk, or Hybrid.

Web Interface

To configure VLAN Port configuration in the web interface:

1. Click VLAN Port Configuration.
2. Specify the VLAN Port Configuration parameters.
3. Click Save.

Ethertype for Custom S-ports 0x

VLAN Port Configuration

Port	Port Type	Ingress Filtering	Frame Type	Egress Rule	PVID
1	Unaware	<input type="checkbox"/>	All	Hybrid	1
2	Unaware	<input type="checkbox"/>	All	Hybrid	1
3	Unaware	<input type="checkbox"/>	All	Hybrid	1
4	Unaware	<input type="checkbox"/>	All	Hybrid	1
5	Unaware	<input type="checkbox"/>	All	Hybrid	1
6	Unaware	<input type="checkbox"/>	All	Hybrid	1
7	Unaware	<input type="checkbox"/>	All	Hybrid	1
8	Unaware	<input type="checkbox"/>	All	Hybrid	1
9A	Unaware	<input type="checkbox"/>	All	Hybrid	1
10A	Unaware	<input type="checkbox"/>	All	Hybrid	1
9B	Unaware	<input type="checkbox"/>	All	Hybrid	1
10B	Unaware	<input type="checkbox"/>	All	Hybrid	1

Parameter description:

Ethertype for Custom S-ports

This field specifies the ether type used for Custom S-ports. This is a global setting for all the Custom S-ports.

Port

This is the logical port number of this row.

Port Type

Port can be one of the following types: Unaware, Customer port(C-port), Service port(S-port), Custom Service port(S-custom-port)

If Port Type is Unaware, all frames are classified to the Port VLAN ID and tags are not removed.

Ingress Filtering

Enable ingress filtering on a port by checking the box. This parameter affects VLAN ingress processing. If ingress filtering is enabled and the ingress port is not a member of the classified VLAN of the frame, the frame is discarded. By default, ingress filtering is disabled (no checkmark).

Frame Type

Determines whether the port accepts all frames or only tagged/untagged frames. This parameter affects VLAN ingress processing. If the port only accepts tagged frames, untagged frames received on the port are discarded. By default, the field is set to All.

Port VLAN Mode

Configures the Port VLAN Mode. The allowed values are None or Specific. This parameter affects VLAN ingress and egress processing.

If None is selected, a VLAN tag with the classified VLAN ID is inserted in frames transmitted on the port. This mode is normally used for ports connected to VLAN aware switches.

If Specific (the default value) is selected, a Port VLAN ID can be configured (see below). Untagged frames received on the port are classified to the Port VLAN ID. If VLAN awareness is disabled, all frames received on the port are classified to the Port VLAN ID. If the classified VLAN ID of a frame transmitted on the port is different from the Port VLAN ID, a VLAN tag with the classified VLAN ID is inserted in the frame.

Port VLAN ID

Configures the VLAN identifier for the port. The allowed values are 1 through 4095. The default value is 1.

Note: The port must be a member of the same VLAN as the Port VLAN ID.

2-10.3 Switch Status

The function Switch Status gathers the information of all VLAN status and reports it by the order of Static NAS MVRP MVP Voice VLAN MSTP GVRP Combined.

Web Interface

To Display VLAN membership status in the web interface:

1. Click VLAN membership.
2. Specify the Static NAS MVRP MVP Voice VLAN MSTP GVRP Combined.
3. Display membership information.

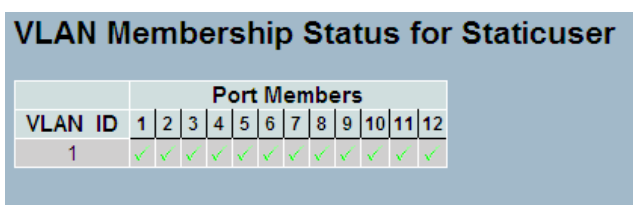

VLAN ID	Port Members											
	1	2	3	4	5	6	7	8	9	10	11	12
1	✓	✓	✓	✓	✓	✓	✓	✓	✓	✓	✓	✓

Parameter description:

VLAN USER

VLAN User module uses services of the VLAN management functionality to configure VLAN memberships and VLAN port configurations such as PVID and UVID. Currently we support the following VLAN user types:

CLI/Web/SNMP : These are referred to as static.

NAS : NAS provides port-based authentication, which involves communications between a Supplicant, Authenticator, and an Authentication Server.

MVRP : Multiple VLAN Registration Protocol (MVRP) allows dynamic registration and deregistration of VLANs on ports on a VLAN bridged network.

GVRP : GARP VLAN Registration Protocol (GVRP) allows dynamic registration and deregistration of VLANs on ports on a VLAN bridged network.

Voice VLAN : Voice VLAN is a VLAN configured specially for voice traffic typically originating from IP phones.

MVR : MVR is used to eliminate the need to duplicate multicast traffic for subscribers in each VLAN. Multicast traffic for all channels is sent only on a single (multicast) VLAN.

MSTP : The 802.1s Multiple Spanning Tree protocol (MSTP) uses VLANs to create multiple spanning trees in a network, which significantly improves network resource utilization while maintaining a loop-free environment.

VLAN Membership

The VLAN Membership Status Page shall show the current VLAN port members for all VLANs configured by a selected VLAN User (selection shall be allowed by a Combo Box). When ALL VLAN Users are selected, it shall show this information for all the VLAN Users, and this is by default. VLAN membership allows the frames classified to the VLAN ID to be forwarded on the respective VLAN member ports.

2-10.4 Port Status

The function Port Status gathers the information of all VLAN status and reports it by the order of Static NAS MVRP MVP Voice VLAN MSTP GVRP Combined.

Web Interface

To Display VLAN Port Status in the web interface:

1. Click VLAN Port Status.
2. Specify the Static NAS MVRP MVP Voice VLAN MSTP GVRP Combined.
3. Display Port Status information.

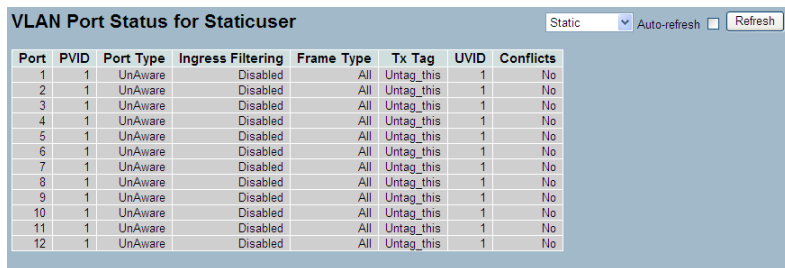

Port	PVID	Port Type	Ingress Filtering	Frame Type	Tx Tag	UVID	Conflicts
1	1	UnAware	Disabled	All	Untag_this	1	No
2	1	UnAware	Disabled	All	Untag_this	1	No
3	1	UnAware	Disabled	All	Untag_this	1	No
4	1	UnAware	Disabled	All	Untag_this	1	No
5	1	UnAware	Disabled	All	Untag_this	1	No
6	1	UnAware	Disabled	All	Untag_this	1	No
7	1	UnAware	Disabled	All	Untag_this	1	No
8	1	UnAware	Disabled	All	Untag_this	1	No
9	1	UnAware	Disabled	All	Untag_this	1	No
10	1	UnAware	Disabled	All	Untag_this	1	No
11	1	UnAware	Disabled	All	Untag_this	1	No
12	1	UnAware	Disabled	All	Untag_this	1	No

Parameter description:

Port

The logical port for the settings contained in the same row.

PVID

Shows the VLAN identifier for that port. The allowed values are 1 through 4095. The default value is 1.

Port Type

Shows the Port Type. Port type can be any of Unaware, C-port, S-port, Custom S-port.

If Port Type is Unaware, all frames are classified to the Port VLAN ID and tags are not removed.

C-port is Customer Port. S-port is Service port. Custom S-port is S-port with Custom TPID.

Ingress Filtering

Shows the ingress filtering on a port. This parameter affects VLAN ingress processing. If ingress filtering is enabled and the ingress port is not a member of the classified VLAN, the frame is discarded.

Frame Type

Shows whether the port accepts all frames or only tagged frames. This parameter affects VLAN ingress processing. If the port only accepts tagged frames, untagged frames received on that port are discarded.

Tx Tag

Shows egress filtering frame status whether tagged or untagged.

UVID

Shows UVID (untagged VLAN ID). Port's UVID determines the packet's behaviour at the egress side.

Conflicts

Shows status of Conflicts whether exists or not. When a Volatile VLAN User requests to set VLAN membership or VLAN port configuration, the following conflicts can occur:

Functional Conflicts between features.

Conflicts due to hardware limitation.

Direct conflict between user modules.

2-10.5 Private VLANs

In a private VLAN, communication between ports in that private VLAN is not permitted. A VLAN can be configured as a private VLAN.

2-10.5.1 Private VLANs Membership

The Private VLAN membership configurations for the switch can be monitored and modified here. Private VLANs can be added or deleted here. Port members of each Private VLAN can be added or removed here.

Private VLANs are based on the source port mask, and there are no connections to VLANs. This means that VLAN IDs and Private VLAN IDs can be identical.

A port must be a member of both a VLAN and a Private VLAN to be able to forward packets. By default, all ports are VLAN unaware and members of VLAN 1 and Private VLAN 1.

A VLAN unaware port can only be a member of one VLAN, but it can be a member of multiple Private VLANs.

Web Interface

To configure Private VLAN configuration in the web interface:

1. Click add new Private VLAN configuration
2. Specify the Private VLAN ID and Port Members
3. Click Save.

Private VLAN Membership Configuration													
		Port Members											
Delete	PVLAN ID	1	2	3	4	5	6	7	8	9	10	11	12
<input type="checkbox"/>	1	<input checked="" type="checkbox"/>	<input checked="" type="checkbox"/>	<input checked="" type="checkbox"/>	<input checked="" type="checkbox"/>	<input checked="" type="checkbox"/>	<input checked="" type="checkbox"/>	<input checked="" type="checkbox"/>	<input checked="" type="checkbox"/>	<input checked="" type="checkbox"/>	<input checked="" type="checkbox"/>	<input checked="" type="checkbox"/>	<input checked="" type="checkbox"/>

Parameter description:

Delete

To delete a private VLAN entry, check this box. The entry will be deleted during the next save.

Private VLAN ID

Indicates the ID of this particular private VLAN.

Port Members

A row of check boxes for each port is displayed for each private VLAN ID. To include a port in a Private VLAN, check the box. To remove or exclude the port from the Private VLAN, make sure the box is unchecked. By default, no ports are members, and all boxes are unchecked.

Adding a New Private VLAN

Click to add a new private VLAN ID. An empty row is added to the table, and the private VLAN can be configured as needed. The allowed range for a private VLAN ID is the same as the switch port number range. Any values outside this range are not accepted, and a warning message appears. Click "OK" to discard the incorrect entry, or click "Cancel" to return to the editing and make a correction.

The Private VLAN is enabled when you click "Save".

The button can be used to undo the addition of new Private VLANs.

2-10.5.1.1 Port Isolation

Port Isolation provides for an apparatus and method to isolate ports on layer 2 switches on the same VLAN to restrict traffic flow. The apparatus comprises a switch having said plurality of ports, each port configured as a protected port or a non-protected port. An address table memory stores an address table having a destination address and port number pair. A forwarding map generator generates a forwarding map which is responsive to a destination address of a data packet. The method for isolating ports on a layer 2 switch comprises configuring each of the ports on the layer 2 switch as a protected port or a non-protected port. A destination address on an data packet is matched with a physical address on said layer 2 switch and a forwarding map is generated for the data packet based upon the destination address on the data packet. The data packet is then sent to the plurality of ports pursuant to the forwarding map generated based upon whether the ingress port was configured as a protected or non-protected port.

This page is used for enabling or disabling port isolation on ports in a Private VLAN. A port member of a VLAN can be isolated to other isolated ports on the same VLAN and Private VLAN.

Web Interface

To configure Port Isolation configuration in the web interface:

1. Click VLAN, Port Isolation.
2. Evoke which port want to enable Port Isolation
3. Click Save.

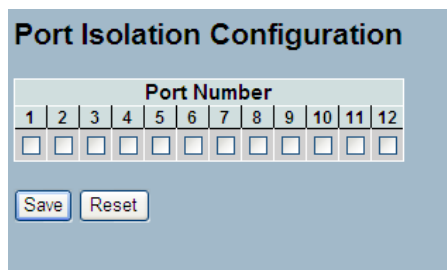

Port Number											
1	2	3	4	5	6	7	8	9	10	11	12
<input type="checkbox"/>	<input type="checkbox"/>	<input type="checkbox"/>	<input type="checkbox"/>	<input type="checkbox"/>	<input type="checkbox"/>	<input type="checkbox"/>	<input type="checkbox"/>	<input type="checkbox"/>	<input type="checkbox"/>	<input type="checkbox"/>	<input type="checkbox"/>

Parameter description:

Port Members

A check box is provided for each port of a private VLAN. When checked, port isolation is enabled on that port. When unchecked, port isolation is disabled on that port. By default, port isolation is disabled on all ports.

2-10.5.2 MAC-based VLAN

MAC address-based VLAN decides the VLAN for forwarding an untagged frame based on the source MAC address of the frame.

A most common way of grouping VLAN members is by port, hence the name port-based VLAN. Typically, the device adds the same VLAN tag to untagged packets that are received through the same port. Later on, these packets can be forwarded in the same VLAN. Port-based VLAN is easy to configure, and applies to networks where the locations of terminal devices are relatively fixed. As mobile office and wireless network access gain more popularity, the ports that terminal devices use to access the networks are very often non-fixed. A device may access a network through Port A this time, but through Port B the next time. If Port A and Port B belong to different VLANs, the device will be assigned to a different VLAN the next time it accesses the network. As a result, it will not be able to use the resources in the old VLAN. On the other hand, if Port A and Port B belong to the same VLAN, after terminal devices access the network through Port B, they will have access to the same resources as those accessing the network through Port A do, which brings security issues. To provide user access and ensure data security in the mean time, the MAC-based VLAN technology is developed.

MAC-based VLANs group VLAN members by MAC address. With MAC-based VLAN configured, the device adds a VLAN tag to an untagged frame according to its source MAC address. MAC-based VLANs are mostly used in conjunction with security technologies such as 802.1X to provide secure, flexible network access for terminal devices.

2-10.5.2.1 Configuration

The MAC-based VLAN entries can be configured here. This page allows for adding and deleting MAC-based VLAN entries and assigning the entries to different ports. This page shows only static entries.

Web Interface

To configure MAC address-based VLAN configuration in the web interface:

1. Click MAC address-based VLAN configuration and add new entry.
2. Specify the MAC address and VLAN ID.
3. Click Save.

MAC-based VLAN Membership Configuration

	Delete	MAC Address	VLAN ID	Port Members										
	<input type="checkbox"/>			<input type="checkbox"/>	<input type="checkbox"/>	<input type="checkbox"/>	<input type="checkbox"/>	<input type="checkbox"/>	<input type="checkbox"/>	<input type="checkbox"/>	<input type="checkbox"/>	<input type="checkbox"/>	<input type="checkbox"/>	<input type="checkbox"/>
Currently no entries present														

Parameter description:

Delete

To delete a MAC-based VLAN entry, check this box and press save. The entry will be deleted on the selected switch in the stack.

MAC Address

Indicates the MAC address.

VLAN ID

Indicates the VLAN ID.

Port Members

A row of check boxes for each port is displayed for each MAC-based VLAN entry. To include a port in a MAC-based VLAN, check the box. To remove or exclude the port from the MAC-based VLAN, make sure the box is unchecked. By default, no ports are members, and all boxes are unchecked.

Adding a New MAC-based VLAN

Click to add a new MAC-based VLAN entry. An empty row is added to the table, and the MAC-based VLAN entry can be configured as needed. Any unicast MAC address can be configured for the MAC-based VLAN entry. No broadcast or multicast MAC addresses are allowed. Legal values for a VLAN ID are 1 through 4095.

The MAC-based VLAN entry is enabled on the selected stack switch unit when you click on "Save". A MAC-based VLAN without any port members on any stack unit will be deleted when you click "Save".

The button can be used to undo the addition of new MAC-based VLANs.

2-10.5.2.2 Status

This section shows MAC-based VLAN entries configured by various MAC-based VLAN users. Currently we support following VLAN User types:

NAS : NAS provides port-based authentication, which involves communications between a Supplicant, Authenticator, and an Authentication Server.

Web Interface

To Display MAC-based VLAN configured in the web interface:

1. Click MAC-based VLAN Status.
2. Specify the Static NAS Combined.
3. Display MAC-based information.

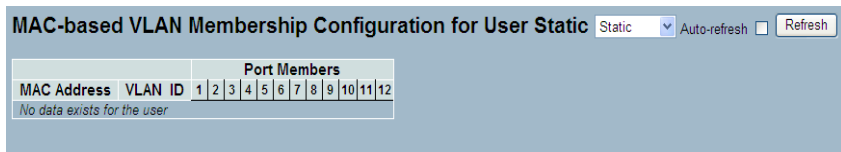

MAC-based VLAN Membership Configuration for User Static												
		Port Members										
MAC Address	VLAN ID	1	2	3	4	5	6	7	8	9	10	11 12
No data exists for the user												

Parameter description:

MAC Address

Indicates the MAC address.

VLAN ID

Indicates the VLAN ID.

Port Members

Port members of the MAC-based VLAN entry.

2-11.5.3 Protocol -based VLAN

This section describe Protocol -based VLAN, The Switch support Protocol include Ethernet LLC SNAP Protocol, LLC

The Logical Link Control (LLC) data communication protocol layer is the upper sub-layer of the Data Link Layer (which is itself layer 2, just above the Physical Layer) in the seven-layer OSI reference model. It provides multiplexing mechanisms that make it possible for several network protocols (IP, IPX, Decnet and Appletalk) to coexist within a multipoint network and to be transported over the same network media, and can also provide flow control and automatic repeat request (ARQ) error management mechanisms.

SNAP

The Subnetwork Access Protocol (SNAP) is a mechanism for multiplexing, on networks using IEEE 802.2 LLC, more protocols than can be distinguished by the 8-bit 802.2 Service Access Point (SAP) fields. SNAP supports identifying protocols by Ethernet type field values; it also supports vendor-private protocol identifier spaces. It is used with IEEE 802.3, IEEE 802.4, IEEE 802.5, IEEE 802.11 and other IEEE 802 physical network layers, as well as with non-IEEE 802 physical network layers such as FDDI that use 802.2 LLC.

2-10.5.3.1 Protocol to Group

This page allows you to add new protocols to Group Name (unique for each Group) mapping entries as well as allow you to see and delete already mapped entries for the selected stack switch unit switch .

Web Interface

To configure Protocol -based VLAN configuration in the web interface:

1. Click Protocol -based VLAN configuration and add new entry.
2. Specify the Ethernet LLC SNAP Protocol and Group Name.
3. Click Save.

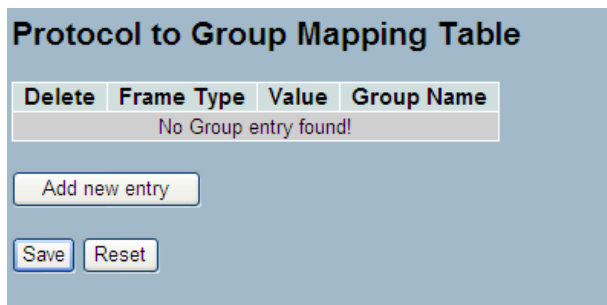

Delete	Frame Type	Value	Group Name
No Group entry found!			

Parameter description:

Delete

To delete a Protocol to Group Name map entry, check this box. The entry will be deleted on the switch during the next Save.

Frame Type

Frame Type can have one of the following values:

1. Ethernet
2. LLC
3. SNAP

Note: On changing the Frame type field, valid value of the following text field will vary depending on the new frame type you selected.

Value

Valid value that can be entered in this text field depends on the option selected from the the preceding Frame Type selection menu.

Below is the criteria for three different Frame Types:

1. For Ethernet: Values in the text field when Ethernet is selected as a Frame Type is called etype. Valid values for etype ranges from 0x0600-0xffff
2. For LLC: Valid value in this case is comprised of two different sub-values.
 - a. DSAP: 1-byte long string (0x00-0xff)
 - b. SSAP: 1-byte long string (0x00-0xff)
3. For SNAP: Valid value in this case also is comprised of two different sub-values.
 - a. OUI: OUI (Organizationally Unique Identifier) is value in format of xx-xx-xx where each pair (xx) in string is a hexadecimal value ranges from 0x00-0xff.
 - b. PID: If the OUI is hexadecimal 000000, the protocol ID is the Ethernet type (EtherType) field value for the protocol running on top of SNAP; if the OUI is an OUI for a particular organization, the protocol ID is a value assigned by that organization to the protocol running on top of SNAP.
In other words, if value of OUI field is 00-00-00 then value of PID will be etype (0x0600-0xffff) and if value of OUI is other than 00-00-00 then valid value of PID will be any value from 0x0000 to 0xffff.

Group Name

A valid Group Name is a unique 16-character long string for every entry which consists of a combination of alphabets (a-z or A-Z) and integers(0-9).

Note: special character and underscore(_) are not allowed.

Adding a New Group to VLAN mapping entry

Click to add a new entry in mapping table. An empty row is added to the table; Frame Type, Value and the Group Name can be configured as needed.

The button can be used to undo the addition of new entry.

2-10.5.3.2 Group Name to VLAN

This section allows you to map a already configured Group Name to a VLAN for the selected stack switch unit switch .

Web Interface

To Display Group Name to VLAN mapping table configured in the web interface:

1. Click Group Name VLAN configuration and add new entry.
2. Specify the Group Name and VLAN ID.
3. Click Save.

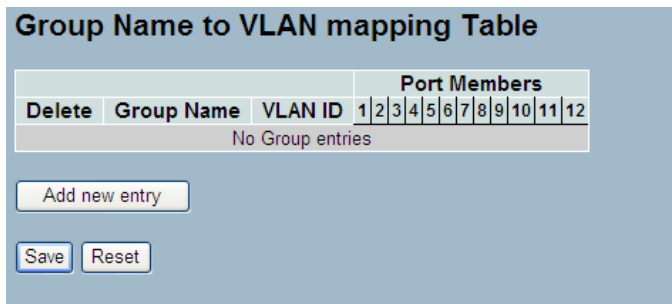

Group Name to VLAN mapping Table			Port Members											
Delete	Group Name	VLAN ID	1	2	3	4	5	6	7	8	9	10	11	12
No Group entries														

Parameter description:

Delete

To delete a Group Name to VLAN map entry, check this box. The entry will be deleted on the switch during the next Save

Group Name

A valid Group Name is a string of atmost 16 characters which consists of a combination of alphabets (a-z or A-Z) and integers(0-9), no special character is allowed. whichever Group name you try map to a VLAN must be present in Protocol to Group mapping table and must not be preused by any other existing mapping entry on this page.

VLAN ID

Indicates the ID to which Group Name will be mapped. A valid VLAN ID ranges from 1-4095.

Port Members

A row of check boxes for each port is displayed for each Group Name to VLAN ID mapping. To include a port in a mapping, check the box. To remove or exclude the port from the mapping, make sure the box is unchecked. By default, no ports are members, and all boxes are unchecked.

Adding a New Group to VLAN mapping entry

Click to add a new entry in mapping table. An empty row is added to the table, the Group Name, VLAN ID and port members can be configured as needed. Legal values for a VLAN ID are 1 through 4095.

The button can be used to undo the addition of new entry.

2-11 Voice VLAN

Voice VLAN is VLAN configured specially for voice traffic. By adding the ports with voice devices attached to voice VLAN, we can perform QoS-related configuration for voice data, ensuring the transmission priority of voice traffic and voice quality.

2-11.1 Configuration

The Voice VLAN feature enables voice traffic forwarding on the Voice VLAN, then the switch can classify and schedule network traffic. It is recommended that there be two VLANs on a port - one for voice, one for data. Before connecting the IP device to the switch, the IP phone should configure the voice VLAN ID correctly. It should be configured through its own GUI.

Web Interface

To configure Voice VLAN in the web interface:

1. Select "Enabled" in the Voice VLAN Configuration.
2. Specify VLAN ID Aging Time Traffic Class.
4. Specify (Port Mode, Security, Discovery Protocol) in the Port Configuration
5. Click Save.

Voice VLAN Configuration	
Mode	Disabled
VLAN ID	1000
Aging Time	86400 seconds
Traffic Class	7 (High)

Port Configuration

Port	Mode	Security	Discovery Protocol
1	Disabled	Disabled	OUI
2	Disabled	Disabled	OUI
3	Disabled	Disabled	OUI
4	Disabled	Disabled	OUI
5	Disabled	Disabled	OUI
6	Disabled	Disabled	OUI
7	Disabled	Disabled	OUI
8	Disabled	Disabled	OUI
9A	Disabled	Disabled	OUI
10A	Disabled	Disabled	OUI
9B	Disabled	Disabled	OUI
10B	Disabled	Disabled	OUI

Save Reset

Parameter description:

Mode

Indicates the Voice VLAN mode operation. We must disable MSTP feature before we enable Voice VLAN. It can avoid the conflict of ingress filtering. Possible modes are:
 Enabled: Enable Voice VLAN mode operation.
 Disabled: Disable Voice VLAN mode operation.

VLAN ID

Indicates the Voice VLAN ID. It should be a unique VLAN ID in the system and cannot equal each port PVID. It is a conflict in configuration if the value equals management VID, MVR VID, PVID etc. The allowed range is 1 to 4095.

Aging Time

Indicates the Voice VLAN secure learning aging time. The allowed range is 10 to 10000000 seconds. It is used when security mode or auto detect mode is enabled. In other cases, it will be based on hardware aging time. The actual aging time will be situated between the [age_time; 2 * age_time] interval.

Traffic Class

Indicates the Voice VLAN traffic class. All traffic on the Voice VLAN will apply this class.

Port Mode

Indicates the Voice VLAN port mode.
 When the port mode isn't equal disabled, we must disable MSTP feature before we enable Voice VLAN. It can avoid the conflict of ingress filtering. Possible port modes are:
 Disabled: Disjoin from Voice VLAN.
 Auto: Enable auto detect mode. It detects whether there is VoIP phone attached to the specific port and configures the Voice VLAN members automatically.
 Forced: Force join to Voice VLAN.

Port Security

Indicates the Voice VLAN port security mode. When the function is enabled, all non-telephonic MAC addresses in the Voice VLAN will be blocked for 10 seconds. Possible port modes are:

Enabled: Enable Voice VLAN security mode operation.

Disabled: Disable Voice VLAN security mode operation.

Port Discovery Protocol

Indicates the Voice VLAN port discovery protocol. It will only work when auto detect mode is enabled. We should enable LLDP feature before configuring discovery protocol to "LLDP" or "Both". Changing the discovery protocol to "OUI" or "LLDP" will restart auto detect process. Possible discovery protocols are:

OUI: Detect telephony device by OUI address.

LLDP: Detect telephony device by LLDP.

Both: Both OUI and LLDP.

2-11.2 OUI

The section describes to Configure VOICE VLAN OUI table . The maximum entry number is 16. Modifying the OUI table will restart auto detection of OUI process.

Web Interface

To configure Voice VLAN OUI Table in the web interface:

1. Select "Add new entry" ,"Delete" in the Voice VLAN OUI table..
2. Specify Telephony OUI, Description..
3. Click Save.

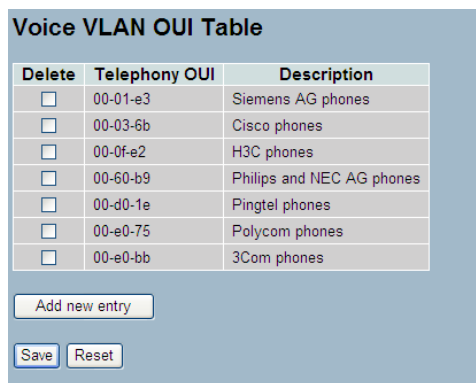

Delete	Telephony OUI	Description
<input type="checkbox"/>	00-01-e3	Siemens AG phones
<input type="checkbox"/>	00-03-6b	Cisco phones
<input type="checkbox"/>	00-0f-e2	H3C phones
<input type="checkbox"/>	00-60-b9	Philips and NEC AG phones
<input type="checkbox"/>	00-d0-1e	Pingtel phones
<input type="checkbox"/>	00-e0-75	Polycom phones
<input type="checkbox"/>	00-e0-bb	3Com phones

Add new entry

Save Reset

Parameter description:

Delete

Check to delete the entry. It will be deleted during the next save.

Telephony OUI

A telephony OUI address is a globally unique identifier assigned to a vendor by IEEE. It must be 6 characters long and the input format is "xx-xx-xx" (x is a hexadecimal digit).

Description

The description of OUI address. Normally, it describes which vendor telephony device it belongs to. The allowed string length is 0 to 32.

2-12 GARP

The Generic Attribute Registration Protocol (GARP) provides a generic framework whereby devices in a bridged LAN, e.g. end stations and switches, can register and de-register attribute values, such as VLAN Identifiers, with each other. In doing so, the attributes are propagated to devices in the bridged LAN, and these devices form a 'reachability' tree that is a subset of an active topology. GARP defines the architecture, rules of operation, state machines and variables for the registration and de-registration of attribute values.

A GARP participation in a switch or an end station consists of a GARP application component, and a GARP Information Declaration (GID) component associated with each port or the switch. The propagation of information between GARP participants for the same application in a bridge is carried out by the GARP Information Propagation (GIP) component. Protocol exchanges take place between GARP participants by means of LLC Type 1 services, using the group MAC address and PDU format defined for the GARP application concerned.

2-12.1 Configuration

This page allows you to configure the basic GARP Configuration settings for all switch ports. The settings relate to the currently selected stack unit, as reflected by the page header.

Web Interface

To configure GARP Port Configuration in the web interface:

1. Click GARP configure.
2. Specify GARP Configuration Parameters..
3. Click Save.

GARP Port Configuration Auto-refresh

Port	Timer Values			Application	Attribute Type	GARP Applicant
	Join Timer	Leave Timer	Leave All Timer			
1	200	600	10000	GVRP	VLAN	normal-participant
2	200	600	10000	GVRP	VLAN	normal-participant
3	200	600	10000	GVRP	VLAN	normal-participant
4	200	600	10000	GVRP	VLAN	normal-participant
5	200	600	10000	GVRP	VLAN	normal-participant
6	200	600	10000	GVRP	VLAN	normal-participant
7	200	600	10000	GVRP	VLAN	normal-participant
8	200	600	10000	GVRP	VLAN	normal-participant
9	200	600	10000	GVRP	VLAN	normal-participant
10	200	600	10000	GVRP	VLAN	normal-participant
11	200	600	10000	GVRP	VLAN	normal-participant
12	200	600	10000	GVRP	VLAN	normal-participant

Parameter description:

Port

The Port column shows the list of ports for which you can configure GARP settings. There are 2 types configuration settings which can be configured on per port bases.

- Timer Values
- Application
- Attribute Type
- GARP Applicant

Application

Currently only supported application is GVRP.

Attribute Type

Currently only supported Attribute Type is VLAN.
GARP Applicant

This configuration is used to configure the Applicant state machine behaviour for GARP on a particular port locally.

- normal-participant: In this mode the Applicant state machine will operate normally in GARP protocol exchanges.
- non-participant: In this mode the Applicant state machine will not participate in the protocol operation.

The default configuration is normal participant.

Timer Values

Three different timers can be configured on this page:

1. Join Timer
2. Leave Timer
3. Leave All Timer

1. Join Timer

The default value for Join timer is 200ms.

2. Leave Timer

The range of values for Leave Time is 600-1000ms. The default value for Leave Timer is 600ms.

3. Leave All Timer

The default value for Leave All Timer is 10000ms

2-12.2 Statistics

The section describes to port statistics of GARP for all switch ports. The port statistics relate to the currently selected stack unit, as reflected by the page header.

Web Interface

To display GARP Port statistics in the web interface:

1. Click GARP statistics.
2. Scroll which port you want to display the GARP Counter information..
3. Click Refresh to modify the GARP statistics information.

Port	Peer MAC	Failed Count
1	--	--
2	--	--
3	--	--
4	--	--
5	--	--
6	--	--
7	--	--
8	--	--
9	--	--
10	--	--
11	--	--
12	--	--

Parameter description:

Port

The Port column shows the list of all ports for which per port GARP statistics are shown.

Peer MAC

Peer MAC is MAC address of the neighbour Switch from which GARP frame is received.

Failed Count

explain Failed count here...

2-13 GVRP

GVRP is an application based on Generic Attribute Registration Protocol (GARP), mainly used to automatically and dynamically maintain the group membership information of the VLANs. The GVRP offers the function providing the VLAN registration service through a GARP application. It makes use of GARP Information Declaration (GID) to maintain the ports associated with their attribute database and GARP Information Propagation (GIP) to communicate among switches and end stations. With GID information and GIP, GVRP state machine maintain the contents of Dynamic VLAN Registration Entries for each VLAN and propagate these information to other GVRP-aware devices to setup and update their knowledge database, the set of VLANs associated with currently active members, and through which ports these members can be reached.

2-13.1 Configuration

This page allows you to configure the basic GVRP Configuration settings for all switch ports. The settings relate to the currently selected stack unit, as reflected by the page header.

Web Interface

To configure GVRP Port Configuration in the web interface:

1. Click GVRP configure.
2. Specify GVRP Configuration Parameters..
3. Click Save.

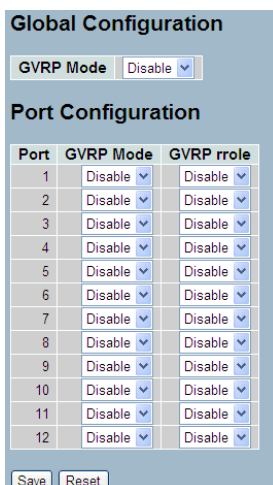

The screenshot shows the 'Global Configuration' web interface. At the top, there is a 'GVRP Mode' dropdown menu set to 'Disable'. Below this is the 'Port Configuration' section, which contains a table with three columns: 'Port', 'GVRP Mode', and 'GVRP rrole'. The table lists ports 1 through 12, with each port having 'Disable' selected for both 'GVRP Mode' and 'GVRP rrole'. At the bottom of the interface, there are 'Save' and 'Reset' buttons.

Port	GVRP Mode	GVRP rrole
1	Disable	Disable
2	Disable	Disable
3	Disable	Disable
4	Disable	Disable
5	Disable	Disable
6	Disable	Disable
7	Disable	Disable
8	Disable	Disable
9	Disable	Disable
10	Disable	Disable
11	Disable	Disable
12	Disable	Disable

Parameter description:

GVRP Mode

GVRP Mode is a global setting, to enable the GVRP globally select 'Enable' from menu and to disable GVRP globally select 'Disable'. In stacking, this configuration command sends message to all the slaves connected in stack. Default value of Global MVRP Mode is 'Disable'

Port

The Port coulumn shows the list of ports for which you can configure per port GVRP settings. There are three configuration settings which can be configured on per port bases.

- GVRP Mode:
- GVRP rrole:

1. GVRP Mode

This configuration is to enable/disable GVRP Mode on perticular port locally.

- Disable: Select to Disable GVRP mode on this port.
- Enable: Select to Enable GVRP mode on this port.

The default value of configuration is disable.

2. GVRP rrole

This configuration is used to configure restricted role on an interface.

- Disable: Select to Disable GVRP rrole on this port.
- Enable: Select to Enable GVRP rrole on this port.

The default configuration is disable.

2-13.2 Statistics

The section describes to shows the basic GVRP Port statistics for all switch ports. The statistics relate to the currently selected stack unit, as reflected by the page header.

Web Interface

To display GVRP Port statistics in the web interface:

1. Click GVRP statistics.
2. Scroll which port you want to display the GVRP Counter information..
3. Click Refresh to modify the GVRP statistics information.

GVRP Port Statistics		
Port	Join Tx Count	Leave Tx Count
1	0	0
2	0	0
3	0	0
4	0	0
5	0	0
6	0	0
7	0	0
8	0	0
9	0	0
10	0	0
11	0	0
12	0	0

Parameter description:

Port

The Port column shows the list of ports for which you can see port counters and statistics.

Join Tx Count

explain Join tx Count here...

Leave Tx Count

explain Leave Tx Count here...

2-14 MRP

This standard specifies protocols, procedures, and managed objects to support the Multiple Registration Protocol (MRP). MRP allows participants in a MRP Application to register attributes with other participants in a Bridged Local Area Network. The definition of attribute types, their values, and the semantics associated with values when registered, are specific to each MRP application. Two Applications are defined, to register VLANs (MVRP) and Group MAC addresses (MMRP).

2-14.1 Configuration

This page allows you to configure the basic MRP Configuration settings for all switch ports. The settings relate to the currently selected stack unit, as reflected by the page header.

: **Web Interface**

To configure MRP Port Configuration in the web interface:

1. Click MRP configure.
2. Specify MRP Configuration Parameters..
3. Click Save.

Port	Timer Values			Application	Attribute Type	MRP Applicant	Periodic Tx
	Join Timer	Leave Timer	Leave All Timer				
1	200	600	10000	MVRP	VLAN	normal-participant	Disable
2	200	600	10000	MVRP	VLAN	normal-participant	Disable
3	200	600	10000	MVRP	VLAN	normal-participant	Disable
4	200	600	10000	MVRP	VLAN	normal-participant	Disable
5	200	600	10000	MVRP	VLAN	normal-participant	Disable
6	200	600	10000	MVRP	VLAN	normal-participant	Disable
7	200	600	10000	MVRP	VLAN	normal-participant	Disable
8	200	600	10000	MVRP	VLAN	normal-participant	Disable
9	200	600	10000	MVRP	VLAN	normal-participant	Disable
10	200	600	10000	MVRP	VLAN	normal-participant	Disable
11	200	600	10000	MVRP	VLAN	normal-participant	Disable
12	200	600	10000	MVRP	VLAN	normal-participant	Disable

Save Reset

Parameter description:

Port

The Port column shows the list of ports for which you can configure MRP settings. There are 2 types configuration settings which can be configured on per port bases.

- Timer Values
- Application
- Attribute Type
- MRP Applicant
- Periodic Tx

Application

Currently only supported application is MVRP.

Attribute Type

Currently only supported Attribute Type is VLAN.

MRP Applicant

This configuration is used to configure the Applicant state machine behaviour for MRP on a particular port locally.

- normal-participant: In this mode the Applicant state machine will operate normally in MRP protocol exchanges.
- non-participant: In this mode the Applicant state machine will not participate in the protocol operation.

The default configuration is normal participant.

Timer Values

Three different timers can be configured on this page:

1. Join Timer
2. Leave Timer
3. Leave All Timer

1. Join Timer

The default value for Join timer is 200ms.

2. Leave Timer

The range of values for Leave Time is 600-1000ms. The default value for Leave Timer is 600ms.

3. Leave All Timer

The default value for Leave All Timer is 10000ms.

Periodic Tx

This configuration is used to configure transmission mode and this can be configured either as enabled or disabled. The default value of Periodic Tx is disabled.

2-14.2 Statistics

This page port statistics of MRP for all switch ports. The port statistics relate to the currently selected stack unit, as reflected by the page header.

Web Interface

To display MRP Port statistics in the web interface:

1. Click MRP statistics.
2. Scroll which port you want to display the MRP Counter information..
3. Click Refresh to modify the MRP statistics information.

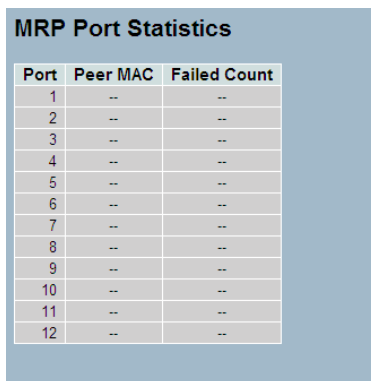

Port	Peer MAC	Failed Count
1	--	--
2	--	--
3	--	--
4	--	--
5	--	--
6	--	--
7	--	--
8	--	--
9	--	--
10	--	--
11	--	--
12	--	--

Parameter description:

Port

The Port column shows the list of all ports for which per port MRP statistics are shown.

Peer MAC

Peer MAC is MAC address of the neighbour Switch from which MRP frame is received.

Failed Count

explain Failed count here...

2-15 MVRP

The Multiple VLAN Registration Protocol (MVRP) defines an MRP application that provides the VLAN registrations service. MVRP provides a mechanism for dynamic maintenance of the contents of Dynamic VLAN Registration Entries for each VLAN, and for propagating the information they contain to other Bridges. This information allows MVRP-aware device to dynamically establish and update their knowledge of the set of VLANs that currently have active members, and through which Ports those members can be reached.

2-15.1 Configuration

This page allows you to configure the basic MVRP Configuration settings for all switch ports. The settings relate to the currently selected stack unit, as reflected by the page header.

Web Interface

To configure MVRP Port Configuration in the web interface:

1. Click MVRP configure.
2. Specify MVRP Configuration Parameters..
3. Click Save.

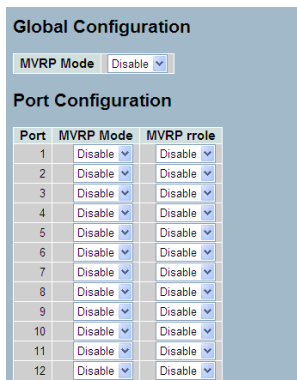

Port	MVRP Mode	MVRP rrole
1	Disable	Disable
2	Disable	Disable
3	Disable	Disable
4	Disable	Disable
5	Disable	Disable
6	Disable	Disable
7	Disable	Disable
8	Disable	Disable
9	Disable	Disable
10	Disable	Disable
11	Disable	Disable
12	Disable	Disable

Parameter description:

MVRP Mode

MVRP Mode is a global setting, to enable the MVRP globally select 'Enable' from menu and to disable MVRP globally select 'Disable'.

In stacking, this configuration command sends message to all the slaves connected in stack.

Default value of Global MVRP Mode is 'Disable'

Port

The Port column shows the list of ports for which you can configure per port MVRP settings. There are three configuration settings which can be configured on per port bases.

- MVRP Mode:
- MVRP role:

1. MVRP Mode

This configuration is to enable/disable MVRP Mode on particular port locally.

- Disable: Select to Disable MVRP mode on this port.
- Enable: Select to Enable MVRP mode on this port.

The default value of configuration is disable.

2. MVRP role

This configuration is used to configure restricted role on an interface.

- Disable: Select to Disable MVRP role on this port.
- Enable: Select to Enable MVRP role on this port.

The default configuration is disable.

2-15.2 Statistics

This page shows the basic MVRP Port statistics for all switch ports. The statistics relate to the currently selected stack unit, as reflected by the page header.

Web Interface

To display MVRP Port statistics in the web interface:

1. Click MVRP statistics.
2. Scroll which port you want to display the MVRP Counter information..
3. Click Refresh to modify the MVRP statistics information.

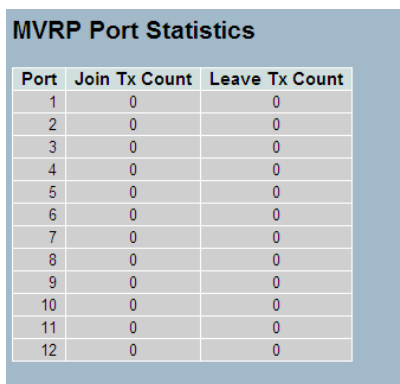

Port	Join Tx Count	Leave Tx Count
1	0	0
2	0	0
3	0	0
4	0	0
5	0	0
6	0	0
7	0	0
8	0	0
9	0	0
10	0	0
11	0	0
12	0	0

Parameter description:

Port

The Port column shows the list of ports for which you can see port counters and statistics.

Join Tx Count

explain Join tx Count here...

Leave Tx Count

explain Leave Tx Count here...

2-16 QoS

The switch support four QoS queues per port with strict or weighted fair queuing scheduling. It supports QoS Control Lists (QCL) for advance programmable QoS classification, based on IEEE 802.1p, Ethertype, VID, IPv4/IPv6 DSCP and UDP/TCP ports and ranges.

High flexibility in the classification of incoming frames to a QoS class. The QoS classification looks for information up to Layer 4, including IPv4 and IPv6 DSCP, IPv4 TCP/UDP port numbers, and user priority of tagged frames. This QoS classification mechanism is implemented in a QoS control list (QCL). The QoS class assigned to a frame is used throughout the device for providing queuing, scheduling, and congestion control guarantees to the frame according to what was configured for that specific QoS class.

The switch support advanced memory control mechanisms providing excellent performance of all QoS classes under any traffic scenario, including jumbo frame. A super priority queue with dedicated memory and strict highest priority in the arbitration. The ingress super priority queue allows traffic recognized as CPU traffic to be received and queued for transmission to the CPU even when all the QoS class queues are congested.

2-16.1 Port Classification

The section allows you to configure the basic QoS Ingress Classification settings for all switch ports. and the settings relate to the currently selected stack unit, as reflected by the page header.

Web Interface

To configure the QoS Port Classification parameters in the web interface:

1. Click Configuration, QoS, Port Classification
2. Scroll to select QoS class, DP Level, PCP and DEI parameters
3. Click the save to save the setting
4. If you want to cancel the setting then you need to click the Reset button.
It will revert to previously saved values

QoS Ingress Port Classification

Port	QoS class	DP level	PCP	DEI	Tag Class.	DSCP Based
1	0	0	0	0	Disabled	<input type="checkbox"/>
2	0	0	0	0	Disabled	<input type="checkbox"/>
3	0	0	0	0	Disabled	<input type="checkbox"/>
4	0	0	0	0	Disabled	<input type="checkbox"/>
5	0	0	0	0	Disabled	<input type="checkbox"/>
6	0	0	0	0	Disabled	<input type="checkbox"/>
7	0	0	0	0	Disabled	<input type="checkbox"/>
8	0	0	0	0	Disabled	<input type="checkbox"/>
9	0	0	0	0	Disabled	<input type="checkbox"/>
10	0	0	0	0	Disabled	<input type="checkbox"/>
11	0	0	0	0	Disabled	<input type="checkbox"/>
12	0	0	0	0	Disabled	<input type="checkbox"/>

Save Reset

Parameter description:

Port

The port number for which the configuration below applies.

QoS class

Controls the default QoS class, i.e., the QoS class for frames not classified in any other way. There is a one to one mapping between QoS class, queue and priority. A QoS class of 0 (zero) has the lowest priority.

DP level

Controls the default DP level, i.e., the DP level for frames not classified in any other way.

PCP

Controls the default PCP for untagged frames.

DEI

Controls the default DEI for untagged frames.

Tag Class.

Shows the classification mode for tagged frames on this port.

Disabled: Use default QoS class and DP level for tagged frames.

Enabled: Use mapped versions of PCP and DEI for tagged frames.

Click on the mode in order to configure the mode and/or mapping.

DSCP Based

Click to Enable DSCP Based QoS Ingress Port Classification.

2-16.2 Port Schedulers

This section provides an overview of QoS Egress Port Schedulers for all switch ports. and the ports belong to the currently selected stack unit, as reflected by the page header.

Web Interface

To display the QoS Port Schedulers in the web interface:

1. Click Configuration, QoS, Port Schedulers

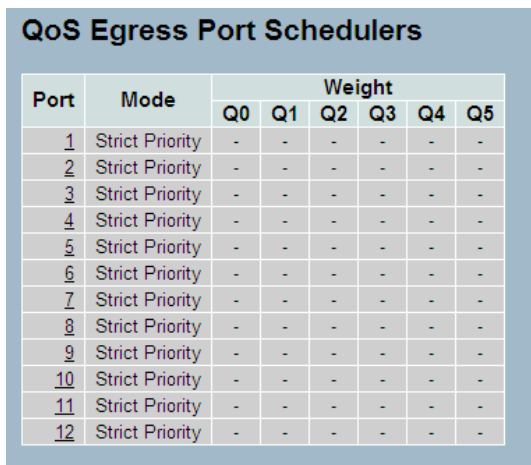

Port	Mode	Weight					
		Q0	Q1	Q2	Q3	Q4	Q5
1	Strict Priority	-	-	-	-	-	-
2	Strict Priority	-	-	-	-	-	-
3	Strict Priority	-	-	-	-	-	-
4	Strict Priority	-	-	-	-	-	-
5	Strict Priority	-	-	-	-	-	-
6	Strict Priority	-	-	-	-	-	-
7	Strict Priority	-	-	-	-	-	-
8	Strict Priority	-	-	-	-	-	-
9	Strict Priority	-	-	-	-	-	-
10	Strict Priority	-	-	-	-	-	-
11	Strict Priority	-	-	-	-	-	-
12	Strict Priority	-	-	-	-	-	-

Parameter description:

Port

The logical port for the settings contained in the same row.
Click on the port number in order to configure the schedulers.

Mode

Shows the scheduling mode for this port.

Qn

Shows the weight for this queue and port.

2-16.3 Port Shapers

This section provides an overview of QoS Egress Port Shapers for all switch ports. Others the user could get all detail information of the ports belong to the currently selected stack unit, as reflected by the page header.

Web Interface

To display the QoS Port Shapers in the web interface:

1. Click Configuration, QoS, Port Shapers

QoS Egress Port Shapers									
Port	Shapers								
	Q0	Q1	Q2	Q3	Q4	Q5	Q6	Q7	Port
1	disabled	disabled	disabled	disabled	disabled	disabled	disabled	disabled	disabled
2	disabled	disabled	disabled	disabled	disabled	disabled	disabled	disabled	disabled
3	disabled	disabled	disabled	disabled	disabled	disabled	disabled	disabled	disabled
4	disabled	disabled	disabled	disabled	disabled	disabled	disabled	disabled	disabled
5	disabled	disabled	disabled	disabled	disabled	disabled	disabled	disabled	disabled
6	disabled	disabled	disabled	disabled	disabled	disabled	disabled	disabled	disabled
7	disabled	disabled	disabled	disabled	disabled	disabled	disabled	disabled	disabled
8	disabled	disabled	disabled	disabled	disabled	disabled	disabled	disabled	disabled
9	disabled	disabled	disabled	disabled	disabled	disabled	disabled	disabled	disabled
10	disabled	disabled	disabled	disabled	disabled	disabled	disabled	disabled	disabled
11	disabled	disabled	disabled	disabled	disabled	disabled	disabled	disabled	disabled
12	disabled	disabled	disabled	disabled	disabled	disabled	disabled	disabled	disabled

Parameter description:

Port

The logical port for the settings contained in the same row.
Click on the port number in order to configure the shapers.

Qn

Shows "disabled" or actual queue shaper rate - e.g. "800 Mbps".

Port

Shows "disabled" or actual port shaper rate - e.g. "800 Mbps".

2-16.4 Port Tag Remarking

The Section provides user to get an overview of QoS Egress Port Tag Remarking for all switch ports. Others the ports belong to the currently selected stack unit, as reflected by the page header. .

Web Interface

To display the QoS Port Tag Remarking in the web interface:

1. Click Configuration, QoS, Port Tag Remarking

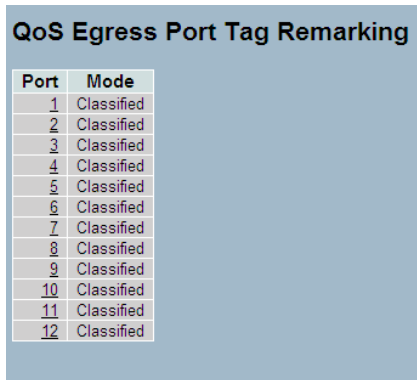

Port	Mode
1	Classified
2	Classified
3	Classified
4	Classified
5	Classified
6	Classified
7	Classified
8	Classified
9	Classified
10	Classified
11	Classified
12	Classified

Parameter description:

Port

The logical port for the settings contained in the same row.
Click on the port number in order to configure tag remarking.

Mode

Shows the tag remarking mode for this port.
Classified: Use classified PCP/DEI values.
Default: Use default PCP/DEI values.
Mapped: Use mapped versions of QoS class and DP level.

2-16.5 Port DSCP

The section will teach user to set the QoS Port DSCP configuration that was allowed you to configure the basic QoS Port DSCP Configuration settings for all switch ports. Others the settings relate to the currently selected stack unit, as reflected by the page header.

Web Interface

To configure the QoS Port DSCP parameters in the web interface:

1. Click Configuration, QoS, Port DSCP
2. Evoke to enable or disable the Ingress Translate and Scroll the Classify Parameter configuration
3. Scroll to select Egress Rewrite parameters
4. Click the save to save the setting
5. If you want to cancel the setting then you need to click the Reset button.
It will revert to previously saved values

Port	Ingress		Egress
	Translate	Classify	Rewrite
1	<input type="checkbox"/>	Disable	Disable
2	<input type="checkbox"/>	Disable	Disable
3	<input type="checkbox"/>	Disable	Disable
4	<input type="checkbox"/>	Disable	Disable
5	<input type="checkbox"/>	Disable	Disable
6	<input type="checkbox"/>	Disable	Disable
7	<input type="checkbox"/>	Disable	Disable
8	<input type="checkbox"/>	Disable	Disable
9	<input type="checkbox"/>	Disable	Disable
10	<input type="checkbox"/>	Disable	Disable
11	<input type="checkbox"/>	Disable	Disable
12	<input type="checkbox"/>	Disable	Disable

Save Reset

Parameter description:

Port

The Port column shows the list of ports for which you can configure dscp ingress and egress settings.

Ingress

In Ingress settings you can change ingress translation and classification settings for individual ports.

There are two configuration parameters available in Ingress:

1. Translate
2. Classify

1. Translate

To Enable the Ingress Translation click the checkbox.

2. Classify

Classification for a port have 4 different values.

- Disable: No Ingress DSCP Classification.
- DSCP=0: Classify if incoming (or translated if enabled) DSCP is 0.
- Selected: Classify only selected DSCP for which classification is enabled as specified in DSCP Translation window for the specific DSCP.
- All: Classify all DSCP.

Egress

Port Egress Rewriting can be one of -

- Disable: No Egress rewrite.
- Enable: Rewrite enable without remapped.
- Remap: DSCP from analyzer is remapped and frame is remarked with remapped DSCP value.

2-16.6 DSCP-Based QoS

The section will teach user to configure the DSCP-Based QoS mode that This page allows you to configure the basic QoS DSCP based QoS Ingress Classification settings for all switches.

Web Interface

To configure the DSCP –Based QoS Ingress Classification parameters in the web interface:

1. Click Configuration, QoS, DSCP-Based QoS
2. Evoke to enable or disable the DSCP for Trust
3. Scroll to select QoS Class and DPL parameters
4. Click the save to save the setting
5. If you want to cancel the setting then you need to click the Reset button. It will revert to previously saved values

DSCP	Trust	QoS Class	DPL
0(BE)	<input checked="" type="checkbox"/>	0	0
1	<input checked="" type="checkbox"/>	0	0
2	<input checked="" type="checkbox"/>	0	0
3	<input checked="" type="checkbox"/>	0	0
4	<input checked="" type="checkbox"/>	0	0
5	<input checked="" type="checkbox"/>	0	0
6	<input checked="" type="checkbox"/>	0	0
7	<input checked="" type="checkbox"/>	0	0
8(CS1)	<input checked="" type="checkbox"/>	0	0
9	<input checked="" type="checkbox"/>	0	0
10	<input checked="" type="checkbox"/>	0	0
11	<input checked="" type="checkbox"/>	0	0
12	<input checked="" type="checkbox"/>	0	0
59	<input checked="" type="checkbox"/>	0	0
60	<input checked="" type="checkbox"/>	0	0
61	<input checked="" type="checkbox"/>	0	0
62	<input checked="" type="checkbox"/>	0	0
63	<input checked="" type="checkbox"/>	0	0

Parameter description:

DSCP

Maximum number of supported DSCP values are 64.

Trust

Click to check if the DSCP value is trusted.

QoS Class

QoS Class value can be any of (0-7)

DPL

Drop Precedence Level (0-3)

2-16.7 DSCP Translation

The section describes the switch allows you to configure the basic QoS DSCP Translation settings for all switches. DSCP translation can be done in Ingress or Egress.

Web Interface

To configure the DSCP Translation parameters in the web interface:

1. Click Configuration, QoS, DSCP Translation
2. Scroll to set the Ingress Translate and Egress Remap DP0 and Remap DP1 Parameters
3. Evoke to enable or disable Classify
4. Click the save to save the setting
5. If you want to cancel the setting then you need to click the Reset button.
It will revert to previously saved values

DSCP	Ingress		Egress	
	Translate	Classify	Remap DP0	Remap DP1
0(BE)	BE	<input type="checkbox"/>	BE	BE
1	1	<input type="checkbox"/>	1	1
2	2	<input type="checkbox"/>	2	2
3	3	<input type="checkbox"/>	3	3
4	4	<input type="checkbox"/>	4	4
5	5	<input type="checkbox"/>	5	5
6	6	<input type="checkbox"/>	6	6
7	7	<input type="checkbox"/>	7	7
8(CS1)	CS1	<input type="checkbox"/>	CS1	CS1
9	9	<input type="checkbox"/>	9	9
10	10	<input type="checkbox"/>	10	10
11	11	<input type="checkbox"/>	11	11
12	12	<input type="checkbox"/>	12	12
13	13	<input type="checkbox"/>	13	13
14	14	<input type="checkbox"/>	14	14
57	57	<input type="checkbox"/>	57	57
58	58	<input type="checkbox"/>	58	58
59	59	<input type="checkbox"/>	59	59
60	60	<input type="checkbox"/>	60	60
61	61	<input type="checkbox"/>	61	61
62	62	<input type="checkbox"/>	62	62
63	63	<input type="checkbox"/>	63	63

Save Reset

Parameter description:

DSCP

Maximum number of supported DSCP values are 64 and valid DSCP value ranges from 0 to 63.

Ingress

Ingress side DSCP can be first translated to new DSCP before using the DSCP for QoS class and DPL map.

There are two configuration parameters for DSCP Translation -

1. Translate
2. Classify

DSCP at Ingress side can be translated to any of (0-63) DSCP values.

2. Classify

Click to enable Classification at Ingress side.

Egress

There are following configurable parameters for Egress side -

1. Remap DP0
2. Remap DP1

There is following configurable parameter for Egress side -

- Remap

1. Remap DP0

Select the DSCP value from select menu to which you want to remap.
DSCP value ranges form 0 to 63.

2. Remap DP1

Select the DSCP value from select menu to which you want to remap.
DSCP value ranges form 0 to 63.

Remap

Select the DSCP value from select menu to which you want to remap.
DSCP value ranges form 0 to 63.

2-16.8 DSCP Classification

The section describes to teach user to configure and allows you to map DSCP value to a QoS Class and DPL value. Others the settings relate to the currently selected stack unit, as reflected by the page header.

Web Interface

To configure the DSCP Classification parameters in the web interface:

1. Click Configuration, QoS, DSCP Translation
2. Scroll to set the DSCP Parameters
3. Click the save to save the setting
4. If you want to cancel the setting then you need to click the Reset button.
It will revert to previously saved values



QoS Class	DPL	DSCP
0	0	BE
0	1	BE
1	0	BE
1	1	BE
2	0	BE
2	1	BE
3	0	BE
3	1	BE
4	0	BE
4	1	BE
5	0	BE
5	1	BE
6	0	BE
6	1	BE
7	0	BE
7	1	BE

Parameter description:

QoS Class

Available QoS Class value ranges from 0 to 7. QoS Class (0-7) can be mapped to followed parameters.

DPL

Drop Precedence Level (0-1) can be configured for all available QoS Classes.

DSCP

Select DSCP value (0-63) from DSCP menu to map DSCP to corresponding QoS Class and DPL value

2-16.9 QoS Control List Configuration

The section shows the QoS Control List(QCL), which is made up of the QCEs. Each row describes a QCE that is defined. The maximum number of QCEs is 256 on each switch. Click on the lowest plus sign to add a new QCE to the list.

Web Interface

To configure the QoS Control List parameters in the web interface:

1. Click Configuration, QoS, QoS Control List
2. Click the  to add a new QoS Control List
3. Scroll all parameters and evoke the Port Member to join the QCE rules
4. Click the save to save the setting
5. If you want to cancel the setting then you need to click the Reset button.
It will revert to previously saved values

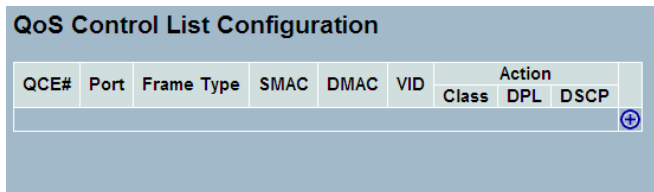

QCE#	Port	Frame Type	SMAC	DMAC	VID	Action			
						Class	DPL	DSCP	
									

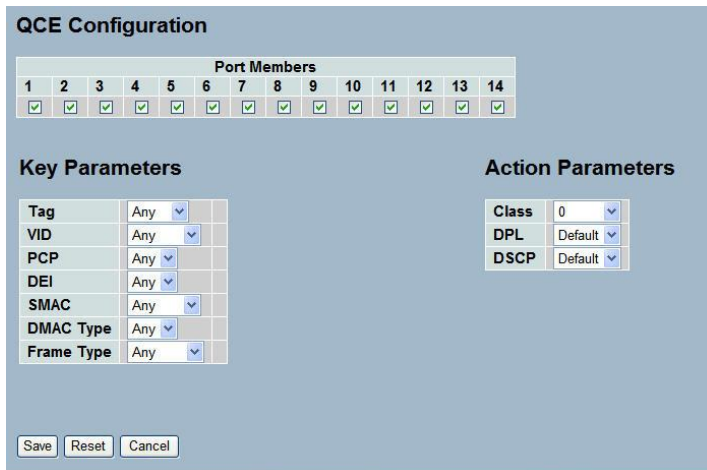

Port Members													
1	2	3	4	5	6	7	8	9	10	11	12	13	14
<input checked="" type="checkbox"/>	<input checked="" type="checkbox"/>	<input checked="" type="checkbox"/>	<input checked="" type="checkbox"/>	<input checked="" type="checkbox"/>	<input checked="" type="checkbox"/>	<input checked="" type="checkbox"/>	<input checked="" type="checkbox"/>	<input checked="" type="checkbox"/>	<input checked="" type="checkbox"/>	<input checked="" type="checkbox"/>	<input checked="" type="checkbox"/>	<input checked="" type="checkbox"/>	<input checked="" type="checkbox"/>

Key Parameters	Action Parameters
Tag: Any	Class: 0
VID: Any	DPL: Default
PCP: Any	DSCP: Default
DEI: Any	
SMAC: Any	
DMAC Type: Any	
Frame Type: Any	

Save Reset Cancel

Parameter description:

QCE#

Indicates the index of QCE.

Switch

Indicates the switch id on which QCE entry is configured. 'Any' indicates QCE is configured on all the switches in the stack.

Port

Indicates the list of ports configured with the QCE.

Frame Type

Indicates the type of frame to look for incoming frames. Possible frame types are:

Any: The QCE will match all frame type.

Ethernet: Only Ethernet frames (with Ether Type 0x600-0xFFFF) are allowed.

LLC: Only (LLC) frames are allowed.

LLC: Only (SNAP) frames are allowed.

IPv4: The QCE will match only IPV4 frames.

IPv6: The QCE will match only IPV6 frames.

SMAC

Displays the OUI field of Source MAC address, i.e. first three octet (byte) of MAC address.

DMAC

Specify the type of Destination MAC addresses for incoming frame.

Possible values are:

Any: All types of Destination MAC addresses are allowed.

Unicast: Only Unicast MAC addresses are allowed.

Multicast: Only Multicast MAC addresses are allowed.

Broadcast: Only Broadcast MAC addresses are allowed.

The default value is 'Any'.

VID

Indicates (VLAN ID), either a specific VID or range of VIDs. VID can be in the range 1-4095 or 'Any'

Conflict

Displays QCE status. It may happen that resources required to add a QCE may not be available, in that case it shows conflict status as 'Yes', otherwise it is always 'No'. Please note that conflict can be resolved by releasing the resource required by the QCE and pressing 'Refresh' button.

Action

Indicates the classification action taken on ingress frame if parameters configured are matched with the frame's content.

There are three action fields: Class, DPL and DSCP.

Class: Classified QoS Class; if a frame matches the QCE it will be put in the queue.

DPL: Drop Precedence Level; if a frame matches the QCE then DP level will be set to value displayed under DPL column.

DSCP: If a frame matches the QCE then DSCP will be classified with the value displayed under DSCP column.

Modification Buttons

You can modify each QCE (QoS Control Entry) in the table using the following buttons:

: Inserts a new QCE before the current row.

: Edits the QCE.

: Moves the QCE up the list.

: Moves the QCE down the list.

: Deletes the QCE.

: The lowest plus sign adds a new entry at the bottom of the QCE listings.

Port Members

Check the checkbox button in case you want to make any port member of the QCL entry. By default all ports will be checked

Key Parameters

Key configuration are described as below:

Tag Value of Tag field can be 'Any', 'Untag' or 'Tag'

VID Valid value of VLAN ID can be any value in the range 1-4095 or 'Any'; user can enter either a specific value or a range of VIDs

PCP Priority Code Point: Valid value PCP are specific(0, 1, 2, 3, 4, 5, 6, 7) or range(0-1, 2-3, 4-5, 6-7, 0-3, 4-7) or 'Any'

DEI Drop Eligible Indicator: Valid value of DEI can be any of values between 0, 1 or 'Any'

SMAC Source MAC address: 24 MS bits (OUI) or 'Any'

DMAC Type Destination MAC type: possible values are unicast(UC), multicast(MC), broadcast(BC) or 'Any'

Frame Type Frame Type can have any of the following values

1. Any
2. Ethernet
3. LLC
4. SNAP
5. IPv4
6. IPv6

Note: all frame types are explained below

1. Any

Allow all types of frames.

2. Ethernet

Ethernet Type Valid ethernet type can have value within 0x600-0xFFFF or 'Any', default value is 'Any'.

3. LLC

SSAP Address Valid SSAP(Source Service Access Point) can vary from 0x00 to 0xFF or 'Any', the default value is 'Any'

DSAP Address Valid DSAP(Destination Service Access Point) can vary from 0x00 to 0xFF or 'Any', the default value is 'Any'

Control Address Valid Control Address can vary from 0x00 to 0xFF or 'Any', the default value is 'Any'

4. SNAP

PID Valid PID(a.k.a ethernet type) can have value within 0x00-0xFFFF or 'Any', default value is 'Any'

5. IPv4

Protocol IP protocol number: (0-255, TCP or UDP) or 'Any'

Source IP Specific Source IP address in value/mask format or 'Any'. IP and Mask are in the format x.y.z.w where x, y, z, and w are decimal numbers between 0 and 255. When Mask is converted to a 32-bit binary string and read from left to right, all bits following the first zero must also be zero

DSCP Diffserv Code Point value(DSCP): It can be specific value, range of value or 'Any'. DSCP values are in the range 0-63 including BE, CS1-CS7, EF or AF11-AF43

IP Fragment IPv4 frame fragmented option: yes|no|any

Sport Source TCP/UDP port:(0-65535) or 'Any', specific or port range applicable for IP protocol UDP/TCP

Dport Destination TCP/UDP port:(0-65535) or 'Any', specific or port range applicable for IP protocol UDP/TCP

6. IPv6

Protocol IP protocol number: (0-255, TCP or UDP) or 'Any'

Source IP IPv6 source address: (a.b.c.d) or 'Any', 32 LS bits

DSCP Diffserv Code Point value(DSCP): It can be specific value, range of value or 'Any'. DSCP values are in the range 0-63 including BE, CS1-CS7, EF or AF11-AF43

Sport Source TCP/UDP port:(0-65535) or 'Any', specific or port range applicable for IP protocol UDP/TCP

Dport Destination TCP/UDP port:(0-65535) or 'Any', specific or port range applicable for IP protocol UDP/TCP

Action Configuration

Class QoS Class: "class (0-7)", default- basic classification
DP Valid DP Level can be (0-3)", default- basic classification
DSCP Valid dscp value can be (0-63, BE, CS1-CS7, EF or AF11-AF43)

2-16.10 QCL Status

The section will let you know how to configure and shows the QCL status by different QCL users. Each row describes the QCE that is defined. It is a conflict if a specific QCE is not applied to the hardware due to hardware limitations. The maximum number of QCEs is 256 on each switch.

Web Interface

To display the QoS Control List Status in the web interface:

1. Click Configuration, QoS , QCL Status
2. If you want to auto-refresh the information then you need to evoke the "Auto-refresh".
3. Scroll to select the combined, static, Voice VLAN and conflict.
4. To Click the " Refresh" to refresh a entry of the MVR Statistics Information.

User	QCE#	Frame Type	Port	Action			Conflict
				Class	DP	DSCP	
No entries							

Parameter description:

User

Indicates the QCL user.

QCE#

Indicates the index of QCE.

Frame Type

Indicates the type of frame to look for incoming frames. Possible frame types are:

Any: The QCE will match all frame type.

Ethernet: Only Ethernet frames (with Ether Type 0x600-0xFFFF) are allowed.

LLC: Only (LLC) frames are allowed.

LLC: Only (SNAP) frames are allowed.

IPv4: The QCE will match only IPv4 frames.

IPv6: The QCE will match only IPv6 frames.

Port

Indicates the list of ports configured with the QCE.

Action

Indicates the classification action taken on ingress frame if parameters configured are matched with the frame's content.

There are three action fields: Class, DPL and DSCP.

Class: Classified QoS Class; if a frame matches the QCE it will be put in the queue.

DPL: Drop Precedence Level; if a frame matches the QCE then DP level will set to value displayed under DPL column.

DSCP: If a frame matches the QCE then DSCP will be classified with the value displayed under DSCP column.

Conflict

Displays QCE status. It may happen that resources required to add a QCE may not available, in that case it shows conflict status as 'Yes', otherwise it is always 'No'. Please note that conflict can be resolved by releasing the resource required by the QCE and pressing 'Refresh' button.

2-16.11 Storm Control

The section allows user to configure the Storm control for the switch. There is a unicast storm rate control, multicast storm rate control, and a broadcast storm rate control. These only affect flooded frames, i.e. frames with a (VLAN ID, DMAC) pair not present on the MAC Address table. The configuration indicates the permitted packet rate for unicast, multicast or broadcast traffic across the switch

Web Interface

To configure the Storm Control Configuration parameters in the web interface:

1. Click Configuration, QoS, Storm Control Configuration
2. Evoke to select the frame type to enable storm control
3. Scroll to set the Rate Parameters
4. Click the save to save the setting
5. If you want to cancel the setting then you need to click the Reset button.
It will revert to previously saved values

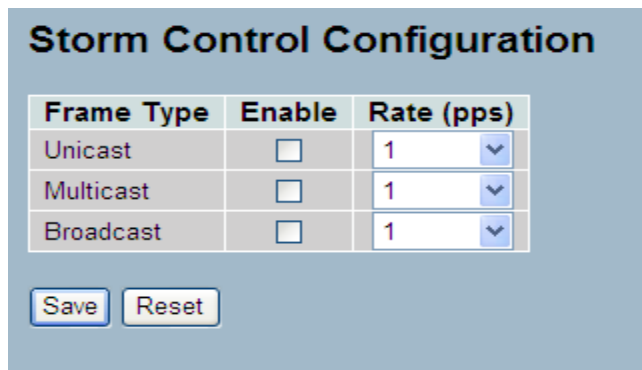

Frame Type	Enable	Rate (pps)
Unicast	<input type="checkbox"/>	1
Multicast	<input type="checkbox"/>	1
Broadcast	<input type="checkbox"/>	1

Save Reset

Parameter description:

Frame Type

The settings in a particular row apply to the frame type listed here: Unicast, Multicast or Broadcast.

Enable

Enable or disable the storm control status for the given frame type.

Rate

The rate unit is packets per second (pps). Valid values are: 1, 2, 4, 8, 16, 32, 64, 128, 256, 512, 1K, 2K, 4K, 8K, 16K, 32K, 64K, 128K, 256K, 512K or 1024K. , 1024K, 2048K, 4096K, 8192K, 16384K or 32768K. , 1024K, 2048K, 4096K, 8192K, 16384K or 32768K.

The 1 kpps is actually 1002.1 pps.

2-17 Thermal Protection

The section allows the user to inspect and configure the current setting for controlling thermal protection. Thermal protection is used to protect the chip from getting overheated.

Web Interface

To configure the Thermal Protection in the web interface:

1. Click Configuration, Thermal Protection , Configuration
2. Specify the temperature in the priority 0 to 3
3. Scroll to set the Priority
4. Click the save to save the setting
5. If you want to cancel the setting then you need to click the Reset button.
It will revert to previously saved values

Thermal Protection Configuration

Temperature settings for priority groups

Priority	Temperature	
0	<input type="text" value="255"/>	°C
1	<input type="text" value="255"/>	°C
2	<input type="text" value="255"/>	°C
3	<input type="text" value="255"/>	°C

Port priorities

Port	Priority
1	<input type="text" value="0"/>
2	<input type="text" value="0"/>
3	<input type="text" value="0"/>
4	<input type="text" value="0"/>
5	<input type="text" value="0"/>
6	<input type="text" value="0"/>

Parameter description:

Temperature settings for priority groups

The temperature at which the ports with the corresponding priority will be turned off.

Port priorities

The priority the port belongs to.

2-17.1 Status

The section allows the user to inspect the thermal status information related to thermal protection when user configure the Thermal protection function already.

Web Interface

To display the Thermal Protection Status in the web interface:

1. Click Configuration, Thermal Protection, Status

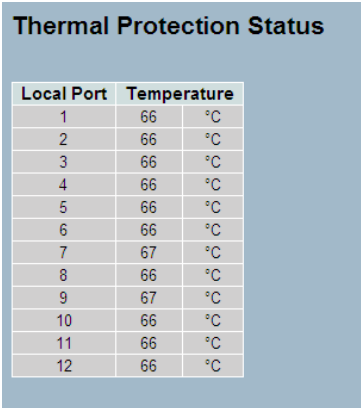

The screenshot shows a web interface titled "Thermal Protection Status". It contains a table with two columns: "Local Port" and "Temperature". The table lists 12 local ports, each with a corresponding temperature in degrees Celsius. The temperatures are mostly 66°C, with ports 7 and 9 showing 67°C.

Local Port	Temperature
1	66 °C
2	66 °C
3	66 °C
4	66 °C
5	66 °C
6	66 °C
7	67 °C
8	66 °C
9	67 °C
10	66 °C
11	66 °C
12	66 °C

Parameter description:

Chip Temperature

Shows the current chip temperature in degrees Celcius.

2-18 Mirror

You can mirror traffic from any source port to a target port for real-time analysis. You can then attach a logic analyzer or RMON probe to the target port and study the traffic crossing the source port in a completely unobtrusive manner.

Mirror Configuration is to monitor the traffic of the network. For example, we assume that Port A and Port B are Monitoring Port and Monitored Port respectively, thus, the traffic received by Port B will be copied to Port A for monitoring.

Web Interface

To configure the Mirror in the web interface:

1. Click Configuration, Mirroring
2. Scroll to select Port to mirror on which port
3. Scroll to disabled, enable, TX Only and RX Only to set the Port mirror mode
4. Click the save to save the setting
5. If you want to cancel the setting then you need to click the Reset button.
It will revert to previously saved values

Port	Mode
1	Disabled
2	Disabled
3	Disabled
4	Disabled
5	Disabled
6	Disabled
7	Disabled
8	Disabled
9	Disabled
10	Disabled
11	Disabled
12	Disabled

Save Reset

Parameter description:

Port to mirror on

Port to mirror also known as the mirror port. Frames from ports that have either source (rx) or destination (tx) mirroring enabled are mirrored on this port. Disabled disables mirroring.

Switch to mirror to

Frames from ports that have either source (rx) or destination (tx) mirroring enabled are mirrored to this switch.

Mirror Port Configuration

The following table is used for Rx and Tx enabling.

Port

The logical port for the settings contained in the same row.

Mode

Select mirror mode.

Rx only Frames received on this port are mirrored on the mirror port.

Frames transmitted are not mirrored.

Tx only Frames transmitted on this port are mirrored on the mirror port.

Frames received are not mirrored.

Disabled Neither frames transmitted nor frames received are mirrored.

Enabled Frames received and frames transmitted are mirrored on the mirror port.

Note: For a given port, a frame is only transmitted once. It is therefore not possible to mirror Tx frames on the mirror port. Because of this, mode for the selected mirror port is limited to Disabled or Rx only.

2-19 Trap Event Severity

The function, is used to set a Alarm trap and get the Event log. The Trap Events Configuration function is used to enable the switch to send out the trap information while pre-defined trap events occurred.

Web Interface

To configure the Trap Event Severity Configuration in the web interface:

1. Click Configuration, Trap Event Severity Configuration
2. Scroll to select the Group name and Severity Level
3. Click the save to save the setting
4. If you want to cancel the setting then you need to click the Reset button.
It will revert to previously saved values

Group Name	Severity Level
ACL	Info
ACL Log	Debug
Access Mgmt	Info
Auth Failed	Warning
Cold Start	Warning
Config Info	Info
Firmware Upgrade	Info
Import Export	Info
Link Status	Warning
Login	Info
Logout	Info
Mgmt IP Change	Info
Module Change	Notice
NAS	Info
Passwd Change	Info
Port Security	Info
VLAN	Info
Warm Start	Warning

2-20 SMTP Configuration

The function, is used to set a Alarm trap when the switch alarm then you

could set the SMTP server to send you the alarm mail.

Web Interface

To configure the SMTP Configuration in the web interface:

1. Click Configuration, SMTP Configuration
2. Scroll to select the Severity Level
3. Specify the parameters in each blank field.
4. Click the save to save the setting
5. If you want to cancel the setting then you need to click the Reset button.
It will revert to previously saved values

SMTP Configuration	
Mail Server	<input type="text"/>
User Name	<input type="text"/>
Password	<input type="text"/>
Serverity Level	Info <input type="button" value="v"/>
Sender	<input type="text"/>
Return Path	<input type="text"/>
Email Address 1	<input type="text"/>
Email Address 2	<input type="text"/>
Email Address 3	<input type="text"/>
Email Address 4	<input type="text"/>
Email Address 5	<input type="text"/>
Email Address 6	<input type="text"/>
<input type="button" value="Save"/> <input type="button" value="Reset"/>	

Parameter description:

These parameters are displayed on the IGMP Group Membership page:

Mail Server :

Specify the IP Address of the server transferring your email.

Username

Specify the username on the mail server.

Password

Specify the password on the mail server.

Sender

To set the mail sender name.

Return-Path

To set the mail return-path as sender mail address.

Email Address 1-6

Email address that would like to receive the alarm message.

3. Security

This chapter describes all of the switch security configuration tasks to enhance the security of local network including IP Source Guard, ARP Inspection, DHCP Snooping, AAA, and etc..

3-1 IP Source Guard

The section describes to configure the IP Source Guard detail parameters of the switch. You could use the IP Source Guard configure to enable or disable with the Port of the switch.

3-1.1 Configuration

This section describes how to configure IP Source Guard setting including :

Mode (Enabled and Disabled)

Maximum Dynamic Clients (0, 1, 2, Unlimited)

Web Interface

To configure an IP Source Guard Configuration in the web interface:

1. Select "Enabled" in the Mode of IP Source Guard Configuration.
2. Select "Enabled" of the specific port in the Mode of Port Mode Configuration.
3. Select Maximum Dynamic Clients (0, 1, 2, Unlimited) of the specific port in the Mode of Port Mode Configuration.
4. Click Save.

IP Source Guard Configuration

Mode

Port Mode Configuration

Port	Mode	Max Dynamic Clients
1	Disabled	Unlimited
2	Disabled	Unlimited
3	Disabled	Unlimited
4	Disabled	Unlimited
5	Disabled	Unlimited
6	Disabled	Unlimited
7	Disabled	Unlimited
8	Disabled	Unlimited
9	Disabled	Unlimited
10	Disabled	Unlimited
11	Disabled	Unlimited
12	Disabled	Unlimited
13	Disabled	Unlimited
14	Disabled	Unlimited

Parameter description:

Mode of IP Source Guard Configuration

Enable the Global IP Source Guard or disable the Global IP Source Guard. All configured ACEs will be lost when the mode is enabled.

Port Mode Configuration

Specify IP Source Guard is enabled on which ports. Only when both Global Mode and Port Mode on a given port are enabled, IP Source Guard is enabled on this given port.

Max Dynamic Clients

Specify the maximum number of dynamic clients that can be learned on given port. This value can be 0, 1, 2 or unlimited. If the port mode is enabled and the value of max dynamic client is equal to 0, it means only allow the IP packets forwarding that are matched in static entries on the specific port.

3-1.2 Static Table

The section describes to configure the Static IP Source Guard Table parameters of the switch. You could use the Static IP Source Guard Table configure to manage the entries.

Web Interface

To configure a Static IP Source Guard Table Configuration in the web interface:

1. Click "Add new entry".
2. Specify the Port, VLAN ID, IP Address, and MAC address in the entry.
3. Click Save.

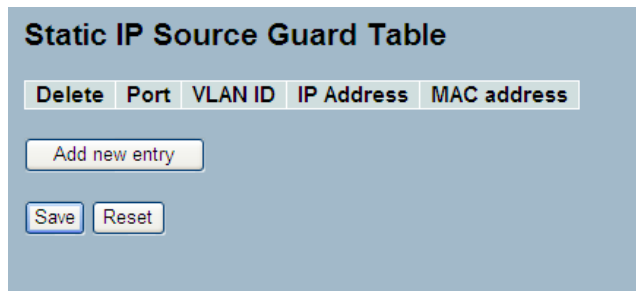

The screenshot shows a web interface for configuring the Static IP Source Guard Table. At the top, there is a title "Static IP Source Guard Table". Below the title is a table with five columns: "Delete", "Port", "VLAN ID", "IP Address", and "MAC address". Below the table is a button labeled "Add new entry". At the bottom of the interface are two buttons: "Save" and "Reset".

Parameter description:

Delete

Check to delete the entry. It will be deleted during the next save.

Port

The logical port for the settings.

VLAN ID

The vlan id for the settings.

IP Address

Allowed Source IP address.

IP Mask

It can be used for calculating the allowed network with IP address.

MAC address

Allowed Source MAC address.

Adding new entry

Click to add a new entry to the Static IP Source Guard table. Specify the Port, VLAN ID, IP address, and IP Mask for the new entry. Click "Save".

3-1.3 Dynamic Table

The section describes to configure the Dynamic IP Source Guard Table parameters of the switch. You could use the Dynamic IP Source Guard Table configure to manage the entries.

Web Interface

To configure a Dynamic IP Source Guard Table Configuration in the web interface:

1. Specify the Start from port, VLAN ID, IP Address, and entrie per page.
2. Checked "Auto-reflash".

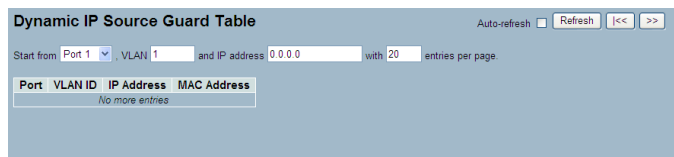

The screenshot shows the 'Dynamic IP Source Guard Table' configuration page. At the top, there is a title bar with 'Dynamic IP Source Guard Table' and 'Auto-refresh' checkbox, 'Refresh' button, and navigation arrows. Below the title bar, there are input fields for 'Start from Port 1', 'VLAN 1', and 'IP address 0.0.0.0', followed by 'with 20 entries per page'. Below these fields is a table with columns 'Port', 'VLAN ID', 'IP Address', and 'MAC Address'. The table currently contains the text 'No more entries'.

Parameter description:

Port

Switch Port Number for which the entries are displayed.

VLAN ID

VLAN-ID in which the IP traffic is permitted.

IP Address

User IP address of the entry.

MAC Address

Source MAC address.

3-2 ARP Inspection

The section describes to configure the ARP Inspection parameters of the switch. You could use the ARP Inspection configuration to manage the ARP table.

3-2.1 Configuration

This section describes how to configure ARP Inspection setting including :
Mode (Enabled and Disabled)
Port (Enabled and Disabled)

Web Interface

To configure an ARP Inspection Configuration in the web interface:

1. Select "Enabled" in the Mode of ARP Inspection Configuration.
2. Select "Enabled" of the specific port in the Mode of Port Mode Configuration.
3. Click Save.

ARP Inspection Configuration

Mode: Disabled

Port Mode Configuration

Port	Mode
1	Disabled
2	Disabled
3	Disabled
4	Disabled
5	Disabled
6	Disabled
7	Disabled
8	Disabled
9	Disabled
10	Disabled
11	Disabled
12	Disabled
13	Disabled
14	Disabled

Save Reset

Parameter description:

Mode of ARP Inspection Configuration

Enable the Global ARP Inspection or disable the Global ARP Inspection.

Port Mode Configuration

Specify ARP Inspection is enabled on which ports. Only when both Global Mode and Port Mode on a given port are enabled, ARP Inspection is enabled on this given port.

3-2.2 Static Table

The section describes to configure the Static ARP Inspection Table parameters of the switch. You could use the Static ARP Inspection Table configure to manage the ARP entries.

Web Interface

To configure a Static ARP Inspection Table Configuration in the web interface:

1. Click "Add new entry".
2. Specify the Port, VLAN ID, IP Address, and MAC address in the entry.
3. Click Save.



The screenshot shows a web interface titled "Static ARP Inspection Table". At the top, there is a table with five columns: "Delete", "Port", "VLAN ID", "MAC Address", and "IP Address". Below the table is a button labeled "Add new entry". At the bottom of the interface are two buttons: "Save" and "Reset".

Parameter description:

Delete

Check to delete the entry. It will be deleted during the next save.

Port

The logical port for the settings.

VLAN ID

The vlan id for the settings.

MAC Address

Allowed Source MAC address in ARP request packets.

IP Address

Allowed Source IP address in ARP request packets.

Adding new entry

Click to add a new entry to the Static ARP Inspection table. Specify the Port, VLAN ID, MAC address, and IP address for the new entry. Click "Save".

3-2.3 Dynamic Table

The section describes to configure the Dynamic ARP Inspection Table parameters of the switch. The Dynamic ARP Inspection Table contains up to 1024 entries, and is sorted first by port, then by VLAN ID, then by MAC address, and then by IP address.

Web Interface

To configure a Dynamic ARP Inspection Table Configuration in the web interface:

1. Specify the Start from port, VLAN ID, MAC Address, IP Address, and entries per page.
2. Checked "Auto-reflash".

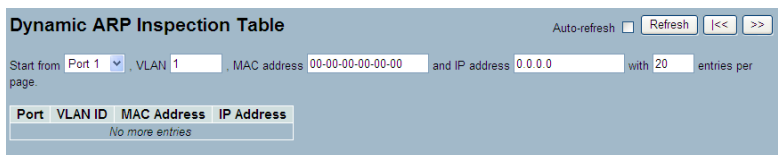

The screenshot shows the 'Dynamic ARP Inspection Table' configuration page. At the top right, there is an 'Auto-refresh' checkbox (unchecked), a 'Refresh' button, and navigation buttons '<<' and '>>'. Below this, the configuration fields are: 'Start from' with a dropdown menu set to 'Port 1', 'VLAN ID' with a text input set to '1', 'MAC address' with a text input set to '00-00-00-00-00-00', and 'and IP address' with a text input set to '0.0.0.0'. To the right of these fields is a 'with 20 entries per page' label. Below the configuration fields is a table header with columns 'Port', 'VLAN ID', 'MAC Address', and 'IP Address'. The table body contains the text 'No more entries'.

Parameter description:

Port

Switch Port Number for which the entries are displayed.

VLAN ID

VLAN-ID in which the ARP traffic is permitted.

MAC Address

User MAC address of the entry.

IP Address

User IP address of the entry.

3-3 DHCP Snooping

The section describes to configure the DHCP Snooping parameters of the switch. The DHCP Snooping can prevent attackers from adding their own DHCP servers to the network.

3-3.1 Configuration

This section describes how to configure DHCP Snooping setting including :
Snooping Mode (Enabled and Disabled)
Port Mode Configuration (Trusted, Untrusted)

Web Interface

To configure a DHCP Snooping in the web interface:

1. Select “Enabled” in the Mode of DHCP Snooping Configuration.
2. Select “Trusted” of the specific port in the Mode of Port Mode Configuration.
3. Click Save.

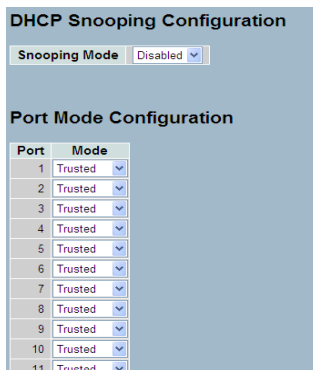

DHCP Snooping Configuration

Snooping Mode: Disabled

Port Mode Configuration

Port	Mode
1	Trusted
2	Trusted
3	Trusted
4	Trusted
5	Trusted
6	Trusted
7	Trusted
8	Trusted
9	Trusted
10	Trusted
11	Trusted

Parameter description:

Snooping Mode

Indicates the DHCP snooping mode operation. Possible modes are:
Enabled: Enable DHCP snooping mode operation. When DHCP snooping mode operation is enabled, the DHCP request messages will be forwarded to trusted ports and only allow reply packets from trusted ports.
Disabled: Disable DHCP snooping mode operation.

Port Mode

Indicates the DHCP snooping port mode. Possible port modes are:
Trusted: Configures the port as trusted source of the DHCP messages.
Untrusted: Configures the port as untrusted source of the DHCP messages.

3-3.2 Statistics

The section describes to show the DHCP Snooping Statistics information of the switch. The statistics show only packet counters when DHCP snooping mode is enabled and relay mode is disabled. And it doesn't count the DHCP packets for DHCP client.

Web Interface

To configure a DHCP Snooping Statistics Configuration in the web interface:

1. Specify the Port which you want to monitor.
2. Checked "Auto-reflash".

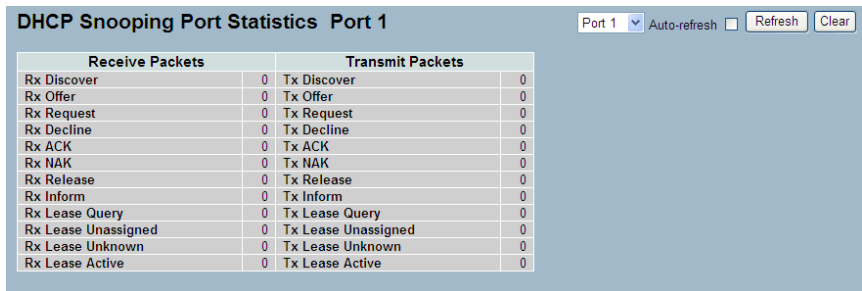

Receive Packets		Transmit Packets	
Rx Discover	0	Tx Discover	0
Rx Offer	0	Tx Offer	0
Rx Request	0	Tx Request	0
Rx Decline	0	Tx Decline	0
Rx ACK	0	Tx ACK	0
Rx NAK	0	Tx NAK	0
Rx Release	0	Tx Release	0
Rx Inform	0	Tx Inform	0
Rx Lease Query	0	Tx Lease Query	0
Rx Lease Unassigned	0	Tx Lease Unassigned	0
Rx Lease Unknown	0	Tx Lease Unknown	0
Rx Lease Active	0	Tx Lease Active	0

Parameter description:

Rx and Tx Discover

The number of discover (option 53 with value 1) packets received and transmitted.

Rx and Tx Offer

The number of offer (option 53 with value 2) packets received and transmitted.

Rx and Tx Request

The number of request (option 53 with value 3) packets received and transmitted.

Rx and Tx Decline

The number of decline (option 53 with value 4) packets received and transmitted.

Rx and Tx ACK

The number of ACK (option 53 with value 5) packets received and transmitted.

Rx and Tx NAK

The number of NAK (option 53 with value 6) packets received and transmitted.

Rx and Tx Release

The number of release (option 53 with value 7) packets received and transmitted.

Rx and Tx Inform

The number of inform (option 53 with value 8) packets received and transmitted.

Rx and Tx Lease Query

The number of lease query (option 53 with value 10) packets received and transmitted.

Rx and Tx Lease Unassigned

The number of lease unassigned (option 53 with value 11) packets received and transmitted.

Rx and Tx Lease Unknown

The number of lease unknown (option 53 with value 12) packets received and transmitted.

Rx and Tx Lease Active

The number of lease active (option 53 with value 13) packets received and transmitted.

3-4 DHCP Relay

The section describes how to forward DHCP requests to another specific DHCP servers via DHCP relay. The DHCP servers may be on another network.

3-4.1 Configuration

This section describes how to configure DHCP Relay setting including :

- Relay Mode (Enabled and Disabled)
- Relay Server IP setting
- Relay Information Mode (Enabled and Disabled)
- Relay Information Mode Policy (Replace, Keep and Drop)

Web Interface

To configure a DHCP Relay in the web interface:

1. Select “Enabled” in the Relay Mode of DHCP Relay Configuration.
2. Specify Relay Server IP address.
3. Select “Enabled” in the Relay Information Mode of DHCP Relay Configuration.
4. Specify Relay (Replace, Keep and Drop) in the Relay Information Mode of DHCP Relay Configuration.
5. Click Save.

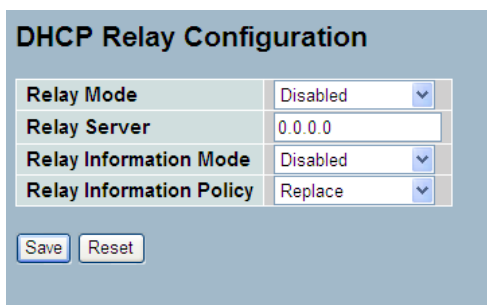

DHCP Relay Configuration	
Relay Mode	Disabled
Relay Server	0.0.0.0
Relay Information Mode	Disabled
Relay Information Policy	Replace

Save Reset

Parameter description:

Relay Mode

Indicates the DHCP relay mode operation. Possible modes are:

Enabled: Enable DHCP relay mode operation. When DHCP relay mode operation is enabled, the agent forwards and transfers DHCP messages between the clients and the server when they are not in the same subnet domain. And the DHCP broadcast message won't be flooded for security considerations.

Disabled: Disable DHCP relay mode operation.

Relay Server

Indicates the DHCP relay server IP address. A DHCP relay agent is used to forward and to transfer DHCP messages between the clients and the server when they are not in the same subnet domain.

Relay Information Mode

Indicates the DHCP relay information mode option operation. Possible modes are:

Enabled: Enable DHCP relay information mode operation. When DHCP relay information mode operation is enabled, the agent inserts specific information (option 82) into a DHCP message when forwarding to DHCP server and removes it from a DHCP message when transferring to DHCP client. It only works when DHCP relay operation mode is enabled.

Disabled: Disable DHCP relay information mode operation.

Relay Information Policy

Indicates the DHCP relay information option policy. When DHCP relay information mode operation is enabled, if agent receives a DHCP message that already contains relay agent information it will enforce the policy. And it only works under DHCP if relay information operation mode is enabled.

Possible policies are:

Replace: Replace the original relay information when a DHCP message that already contains it is received.

Keep: Keep the original relay information when a DHCP message that already contains it is received.

Drop: Drop the package when a DHCP message that already contains relay information is received.

3-4.2 Statistics

The section describes to show the DHCP Relay Statistics information of the switch. The statistics show both of Server and Client packet counters when DHCP Relay mode is enabled.

Web Interface

To configure a DHCP Snooping Statistics Configuration in the web interface:

1. Checked "Auto-reflash".

DHCP Relay Statistics							
Server Statistics							
Transmit to Server	Transmit Error	Receive from Server	Receive Missing Agent Option	Receive Missing Circuit ID	Receive Missing Remote ID	Receive Bad Circuit ID	Receive Bad Remote ID
0	0	0	0	0	0	0	0
Client Statistics							
Transmit to Client	Transmit Error	Receive from Client	Receive Agent Option	Replace Agent Option	Keep Agent Option	Drop Agent Option	
0	0	0	0	0	0	0	

Parameter description:

Transmit to Server

The number of packets that are relayed from client to server.

Transmit Error

The number of packets that resulted in errors while being sent to clients.

Receive from Server

The number of packets received from server.

Receive Missing Agent Option

The number of packets received without agent information options.

Receive Missing Circuit ID

The number of packets received with the Circuit ID option missing.

Receive Missing Remote ID

The number of packets received with the Remote ID option missing.

Receive Bad Circuit ID

The number of packets whose Circuit ID option did not match known circuit ID.

Receive Bad Remote ID

The number of packets whose Remote ID option did not match known Remote ID.

Client Statistics

Transmit to Client

The number of relayed packets from server to client.

Transmit Error

The number of packets that resulted in error while being sent to servers.

Receive from Client

The number of received packets from server.

Receive Agent Option

The number of received packets with relay agent information option.

Replace Agent Option

The number of packets which were replaced with relay agent information option.

Keep Agent Option

The number of packets whose relay agent information was retained.

Drop Agent Option

The number of packets that were dropped which were received with relay agent information.

3-5 NAS

The section describes to configure the NAS parameters of the switch. The NAS server can be employed to connect users to a variety of resources including Internet access, conference calls, printing documents on shared printers, or by simply logging on to the Internet.

3-5.1 Configuration

This section describes how to configure NAS setting of IEEE 802.1X, MAC-based authentication system, and port settings. The NAS configuration consists of two sections, a system- and a port-wide.

Web Interface

To configure a System Configuration of Network Access Server in the web interface:

1. Select "Enabled" in the Mode of Network Access Server Configuration.
2. Checked Reauthentication Enabled.
3. Set Reauthentication Period (Default is 3600 seconds).
4. Set EAPOL Timeout (Default is 30 seconds).
5. Set Aging Period (Default is 300 seconds).
6. Set Hold Time (Default is 10 seconds).
7. Checked RADIUS-Assigned QoS Enabled.
8. Checked RADIUS-Assigned VLAN Enabled.
9. Checked Guest VLAN Enabled.
10. Specify Guest VLAN ID.
11. Specify Max. Reauth. Count.
12. Checked Allow Guest VLAN if EAPOL Seen.
13. Click Save.

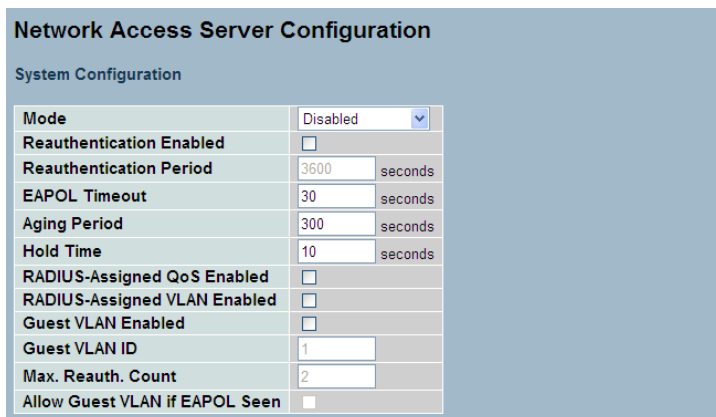

Network Access Server Configuration

System Configuration

Mode	Disabled
Reauthentication Enabled	<input type="checkbox"/>
Reauthentication Period	3600 seconds
EAPOL Timeout	30 seconds
Aging Period	300 seconds
Hold Time	10 seconds
RADIUS-Assigned QoS Enabled	<input type="checkbox"/>
RADIUS-Assigned VLAN Enabled	<input type="checkbox"/>
Guest VLAN Enabled	<input type="checkbox"/>
Guest VLAN ID	1
Max. Reauth. Count	2
Allow Guest VLAN if EAPOL Seen	<input type="checkbox"/>

Parameter description:

Mode

Indicates if NAS is globally enabled or disabled on the switchstack. If globally disabled, all ports are allowed forwarding of frames.

Reauthentication Enabled

If checked, successfully authenticated supplicants/clients are reauthenticated after the interval specified by the Reauthentication Period. Reauthentication for 802.1X-enabled ports can be used to detect if a new device is plugged into a switch port or if a supplicant is no longer attached. For MAC-based ports, reauthentication is only useful if the RADIUS server configuration has changed. It does not involve communication between the switch and the client, and therefore doesn't imply that a client is still present on a port (see Aging Period below).

Reauthentication Period

Determines the period, in seconds, after which a connected client must be reauthenticated. This is only active if the Reauthentication Enabled checkbox is checked. Valid values are in the range 1 to 3600 seconds.

EAPOL Timeout

Determines the time for retransmission of Request Identity EAPOL frames. Valid values are in the range 1 to 255 seconds. This has no effect for MAC-based ports.

Aging Period

This setting applies to the following modes, i.e. modes using the Port Security functionality to secure MAC addresses:

- Single 802.1X
- Multi 802.1X
- MAC-Based Auth.

When the NAS module uses the Port Security module to secure MAC addresses, the Port Security module needs to check for activity on the MAC address in question at regular intervals and free resources if no activity is seen within a given period of time. This parameter controls exactly this period and can be set to a number between 10 and 1000000 seconds. If reauthentication is enabled and the port is in an 802.1X-based mode, this is not so critical, since supplicants that are no longer attached to the port will get removed upon the next reauthentication, which will fail. But if reauthentication is not enabled, the only way to free resources is by aging the entries.

For ports in MAC-based Auth. mode, reauthentication doesn't cause direct communication between the switch and the client, so this will not detect whether the client is still attached or not, and the only way to free any resources is to age the entry.

Hold Time

This setting applies to the following modes, i.e. modes using the Port

Security functionality to secure MAC addresses:

- Single 802.1X
- Multi 802.1X
- MAC-Based Auth.

If a client is denied access - either because the RADIUS server denies the client access or because the RADIUS server request times out (according to the timeout specified on the "Configuration→Security→AAA" page) - the client is put on hold in the Unauthorized state. The hold timer does not count during an on-going authentication.

In MAC-based Auth. mode, the The switch will ignore new frames coming from the client during the hold time.

The Hold Time can be set to a number between 10 and 1000000 seconds.

RADIUS-Assigned QoS Enabled

RADIUS-assigned QoS provides a means to centrally control the traffic class to which traffic coming from a successfully authenticated supplicant is assigned on the switch. The RADIUS server must be configured to transmit special RADIUS attributes to take advantage of this feature (see RADIUS-Assigned QoS Enabled below for a detailed description).

The "RADIUS-Assigned QoS Enabled" checkbox provides a quick way to globally enable/disable RADIUS-server assigned QoS Class functionality. When checked, the individual ports' ditto setting determine whether RADIUS-assigned QoS Class is enabled on that port. When unchecked, RADIUS-server assigned QoS Class is disabled on all ports.

RADIUS-Assigned VLAN Enabled

RADIUS-assigned VLAN provides a means to centrally control the VLAN on which a successfully authenticated supplicant is placed on the switch. Incoming traffic will be classified to and switched on the RADIUS-assigned VLAN. The RADIUS server must be configured to transmit special RADIUS attributes to take advantage of this feature (see RADIUS-Assigned VLAN Enabled below for a detailed description).

The "RADIUS-Assigned VLAN Enabled" checkbox provides a quick way to globally enable/disable RADIUS-server assigned VLAN functionality. When checked, the individual ports' ditto setting determine whether RADIUS-assigned VLAN is enabled on that port. When unchecked, RADIUS-server assigned VLAN is disabled on all ports.

Guest VLAN Enabled

A Guest VLAN is a special VLAN - typically with limited network access - on which 802.1X-unaware clients are placed after a network administrator-defined timeout. The switch follows a set of rules for entering and leaving the Guest VLAN as listed below.

The "Guest VLAN Enabled" checkbox provides a quick way to globally enable/disable Guest VLAN functionality. When checked, the individual ports' ditto setting determines whether the port can be moved into Guest VLAN. When unchecked, the ability to move to the Guest VLAN is disabled on all ports.

Guest VLAN ID

This is the value that a port's Port VLAN ID is set to if a port is moved into the Guest VLAN. It is only changeable if the Guest VLAN option is globally enabled.

Valid values are in the range [1; 4095].

Max. Reauth. Count

The number of times the switch transmits an EAPOL Request Identity frame without response before considering entering the Guest VLAN is adjusted with this setting. The value can only be changed if the Guest VLAN option is globally enabled.

Valid values are in the range [1; 255].

Allow Guest VLAN if EAPOL Seen

The switch remembers if an EAPOL frame has been received on the port for the life-time of the port. Once the switch considers whether to enter the Guest VLAN, it will first check if this option is enabled or disabled. If disabled (unchecked; default), the switch will only enter the Guest VLAN if an EAPOL frame has not been received on the port for the life-time of the port. If enabled (checked), the switch will consider entering the Guest VLAN even if an EAPOL frame has been received on the port for the life-time of the port.

The value can only be changed if the Guest VLAN option is globally enabled.

Port Configuration

The table has one row for each port on the selected switch in the stack and a number of columns, which are:

Port

The port number for which the configuration below applies.

Admin State

If NAS is globally enabled, this selection controls the port's authentication mode. The following modes are available:

Force Authorized

In this mode, the switch will send one EAPOL Success frame when the port link comes up, and any client on the port will be allowed network access without authentication.

Force Unauthorized

In this mode, the switch will send one EAPOL Failure frame when the port link comes up, and any client on the port will be disallowed network access.

Port-based 802.1X

In the 802.1X-world, the user is called the supplicant, the switch is the authenticator, and the RADIUS server is the authentication server. The authenticator acts as the man-in-the-middle, forwarding requests and responses between the supplicant and the authentication server. Frames sent between the supplicant and the switch are special 802.1X frames, known as EAPOL (EAP Over LANs) frames. EAPOL frames encapsulate EAP PDUs (RFC3748). Frames sent between the switch and the RADIUS server are RADIUS packets. RADIUS packets also encapsulate EAP PDUs together with other attributes like the switch's IP address, name, and the supplicant's port number on the switch. EAP is very flexible, in that it allows for different authentication methods, like MD5-Challenge, PEAP, and TLS. The important thing is that the authenticator (the switch) doesn't need to know which authentication method the supplicant and the authentication server are using, or how many information exchange frames are needed for a particular method. The switch simply encapsulates the EAP part of the frame into the relevant type (EAPOL or RADIUS) and forwards it.

When authentication is complete, the RADIUS server sends a special packet containing a success or failure indication. Besides forwarding this decision to the supplicant, the switch uses it to open up or block traffic on the switch port connected to the supplicant.

Note: Suppose two backend servers are enabled and that the server timeout is configured to X seconds (using the AAA configuration page), and suppose that the first server in the list is currently down (but not considered dead). Now, if the supplicant retransmits EAPOL Start frames at a rate faster than X seconds, then it will never get authenticated, because the switch will cancel on-going backend authentication server requests whenever it receives a new EAPOL Start frame from the supplicant. And since the server hasn't yet failed (because the X seconds haven't expired), the same server will be contacted upon the next backend authentication server request from the switch. This scenario will loop forever. Therefore, the server timeout should be smaller than the supplicant's EAPOL Start frame retransmission rate.

Single 802.1X

In port-based 802.1X authentication, once a supplicant is successfully authenticated on a port, the whole port is opened for network traffic. This allows other clients connected to the port (for instance through a hub) to piggy-back on the successfully authenticated client and get network access even though they really aren't authenticated. To overcome this security breach, use the Single 802.1X variant. Single 802.1X is really not an IEEE standard, but features many of the same characteristics as does port-based 802.1X. In Single 802.1X, at most one supplicant can get authenticated on the port at a time. Normal EAPOL frames are used in the communication between the supplicant and the switch. If more than one supplicant is connected to a port, the one that comes first when the port's link comes up will be the first one considered. If that supplicant doesn't provide valid credentials within a certain amount of time, another supplicant will get a chance. Once a supplicant is successfully authenticated, only that supplicant will be allowed access. This is the most secure of all the supported modes. In this mode, the Port Security module is used to secure a supplicant's MAC address once successfully authenticated.

Multi 802.1X

In port-based 802.1X authentication, once a supplicant is successfully authenticated on a port, the whole port is opened for network traffic. This allows other clients connected to the port (for instance through a hub) to piggy-back on the successfully authenticated client and get network access even though they really aren't authenticated. To overcome this security breach, use the Multi 802.1X variant.

Multi 802.1X is really not an IEEE standard, but features many of the same characteristics as does port-based 802.1X. Multi 802.1X is - like Single 802.1X - not an IEEE standard, but a variant that features many of the same characteristics. In Multi 802.1X, one or more supplicants can get authenticated on the same port at the same time. Each supplicant is authenticated individually and secured in the MAC table using the Port Security module.

In Multi 802.1X it is not possible to use the multicast BPDU MAC address as destination MAC address for EAPOL frames sent from the switch towards the supplicant, since that would cause all supplicants attached to the port to reply to requests sent from the switch. Instead, the switch uses the supplicant's MAC address, which is obtained from the first EAPOL Start or EAPOL Response Identity frame sent by the supplicant. An exception to this is when no supplicants are attached. In this case, the switch sends EAPOL Request Identity frames using the BPDU multicast MAC address as destination - to wake up any supplicants that might be on the port.

The maximum number of supplicants that can be attached to a port can be limited using the Port Security Limit Control functionality.

MAC-based Auth.

Unlike port-based 802.1X, MAC-based authentication is not a standard, but merely a best-practices method adopted by the industry. In MAC-based authentication, users are called clients, and the switch acts as the supplicant on behalf of clients. The initial frame (any kind of frame) sent by a client is snooped by the switch, which in turn uses the client's MAC address as both username and password in the subsequent EAP exchange with the RADIUS server. The 6-byte MAC address is converted to a string on the following form "xx-xx-xx-xx-xx-xx", that is, a dash (-) is used as separator between the lower-cased hexadecimal digits. The switch only supports the MD5-Challenge authentication method, so the RADIUS server must be configured accordingly.

When authentication is complete, the RADIUS server sends a success or failure indication, which in turn causes the switch to open up or block traffic for that particular client, using the Port Security module. Only then will frames from the client be forwarded on the switch. There are no EAPOL frames involved in this authentication, and therefore, MAC-based Authentication has nothing to do with the 802.1X standard.

The advantage of MAC-based authentication over port-based 802.1X is that several clients can be connected to the same port (e.g. through a 3rd party switch or a hub) and still require individual authentication, and that the clients don't need special supplicant software to authenticate. The advantage of MAC-based authentication over 802.1X-based authentication is that the clients don't need special supplicant software to authenticate. The disadvantage is that MAC addresses can be spoofed by malicious users - equipment whose MAC address is a valid RADIUS user can be used by anyone. Also, only the MD5-Challenge method is supported. The maximum number of clients that can be attached to a port can be limited

using the Port Security Limit Control functionality.

RADIUS-Assigned QoS Enabled

When RADIUS-Assigned QoS is both globally enabled and enabled (checked) on a given port, the switch reacts to QoS Class information carried in the RADIUS Access-Accept packet transmitted by the RADIUS server when a supplicant is successfully authenticated. If present and valid, traffic received on the supplicant's port will be classified to the given QoS Class. If (re-)authentication fails or the RADIUS Access-Accept packet no longer carries a QoS Class or it's invalid, or the supplicant is otherwise no longer present on the port, the port's QoS Class is immediately reverted to the original QoS Class (which may be changed by the administrator in the meanwhile without affecting the RADIUS-assigned).

This option is only available for single-client modes, i.e.

- Port-based 802.1X
- Single 802.1X

RADIUS attributes used in identifying a QoS Class:

Refer to the written documentation for a description of the RADIUS attributes needed in order to successfully identify a QoS Class. The User-Priority-Table attribute defined in RFC4675 forms the basis for identifying the QoS Class in an Access-Accept packet.

Only the first occurrence of the attribute in the packet will be considered, and to be valid, it must follow this rule:

- All 8 octets in the attribute's value must be identical and consist of ASCII characters in the range '0' - '3', which translates into the desired QoS Class in the range [0; 3].

RADIUS-Assigned VLAN Enabled

When RADIUS-Assigned VLAN is both globally enabled and enabled (checked) for a given port, the switch reacts to VLAN ID information carried in the RADIUS Access-Accept packet transmitted by the RADIUS server when a supplicant is successfully authenticated. If present and valid, the port's Port VLAN ID will be changed to this VLAN ID, the port will be set to be a member of that VLAN ID, and the port will be forced into VLAN unaware mode. Once assigned, all traffic arriving on the port will be classified and switched on the RADIUS-assigned VLAN ID.

If (re-)authentication fails or the RADIUS Access-Accept packet no longer carries a VLAN ID or it's invalid, or the supplicant is otherwise no longer present on the port, the port's VLAN ID is immediately reverted to the original VLAN ID (which may be changed by the administrator in the meanwhile without affecting the RADIUS-assigned).

This option is only available for single-client modes, i.e.

- Port-based 802.1X
- Single 802.1X

For trouble-shooting VLAN assignments, use the "Monitor→VLANs→VLAN Membership and VLAN Port" pages. These pages show which modules have (temporarily) overridden the current Port VLAN configuration.

RADIUS attributes used in identifying a VLAN ID:

RFC2868 and RFC3580 form the basis for the attributes used in identifying a VLAN ID in an Access-Accept packet. The following criteria are used:

- The Tunnel-Medium-Type, Tunnel-Type, and Tunnel-Private-Group-ID attributes must all be present at least once in the Access-Accept packet.

- The switch looks for the first set of these attributes that have the same Tag value and fulfil the following requirements (if Tag == 0 is used, the Tunnel-Private-Group-ID does not need to include a Tag):
 - Value of Tunnel-Medium-Type must be set to "IEEE-802" (ordinal 6).
 - Value of Tunnel-Type must be set to "VLAN" (ordinal 13).
 - Value of Tunnel-Private-Group-ID must be a string of ASCII chars in the range '0' - '9', which is interpreted as a decimal string representing the VLAN ID. Leading '0's are discarded. The final value must be in the range [1; 4095].

Guest VLAN Enabled

When Guest VLAN is both globally enabled and enabled (checked) for a given port, the switch considers moving the port into the Guest VLAN according to the rules outlined below.

This option is only available for EAPOL-based modes, i.e.:

- Port-based 802.1X
- Single 802.1X
- Multi 802.1X

For trouble-shooting VLAN assignments, use the "Monitor→VLANs→VLAN Membership and VLAN Port" pages. These pages show which modules have (temporarily) overridden the current Port VLAN configuration.

Guest VLAN Operation:

When a Guest VLAN enabled port's link comes up, the switch starts transmitting EAPOL Request Identity frames. If the number of transmissions of such frames exceeds Max. Reauth. Count and no EAPOL frames have been received in the meanwhile, the switch considers entering the Guest VLAN. The interval between transmission of EAPOL Request Identity frames is configured with EAPOL Timeout. If Allow Guest VLAN if EAPOL Seen is enabled, the port will now be placed in the Guest VLAN. If disabled, the switch will first check its history to see if an EAPOL frame has previously been received on the port (this history is cleared if the port link goes down or the port's Admin State is changed), and if not, the port will be placed in the Guest VLAN. Otherwise it will not move to the Guest VLAN, but continue transmitting EAPOL Request Identity frames at the rate given by EAPOL Timeout.

Once in the Guest VLAN, the port is considered authenticated, and all attached clients on the port are allowed access on this VLAN. The switch will not transmit an EAPOL Success frame when entering the Guest VLAN. While in the Guest VLAN, the switch monitors the link for EAPOL frames, and if one such frame is received, the switch immediately takes the port out of the Guest VLAN and starts authenticating the supplicant according to the port mode. If an EAPOL frame is received, the port will never be able to go back into the Guest VLAN if the "Allow Guest VLAN if EAPOL Seen" is disabled.

Port State

The current state of the port. It can undertake one of the following values:
Globally Disabled: NAS is globally disabled.

Link Down: NAS is globally enabled, but there is no link on the port.

Authorized: The port is in Force Authorized or a single-supplicant mode and the supplicant is authorized.

Unauthorized: The port is in Force Unauthorized or a single-suppliant mode and the supplicant is not successfully authorized by the RADIUS server.

X Auth/Y Unauth: The port is in a multi-suppliant mode. Currently X clients are authorized and Y are unauthorized.

Restart

Two buttons are available for each row. The buttons are only enabled when authentication is globally enabled and the port's Admin State is in an EAPOL-based or MAC-based mode.

Clicking these buttons will not cause settings changed on the page to take effect.

Reauthenticate: Schedules a reauthentication whenever the quiet-period of the port runs out (EAPOL-based authentication). For MAC-based authentication, reauthentication will be attempted immediately.

The button only has effect for successfully authenticated clients on the port and will not cause the clients to get temporarily unauthorized.

Reinitialize: Forces a reinitialization of the clients on the port and thereby a reauthentication immediately. The clients will transfer to the unauthorized state while the reauthentication is in progress.

3-5.2 Switch Status

The section describes to show the each port NAS status information of the switch. The status includes Admin State Port State, Last Source, Last ID, QoS Class, and Port VLAN ID.

Web Interface

To configure a NAS Switch Status Configuration in the web interface:

1. Checked "Auto-reflash".

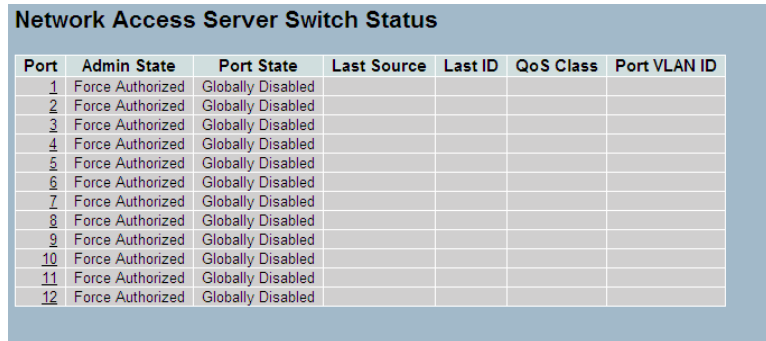

The screenshot shows a table titled "Network Access Server Switch Status" with 7 columns: Port, Admin State, Port State, Last Source, Last ID, QoS Class, and Port VLAN ID. The table contains 12 rows of data, all with "Force Authorized" in the Admin State and "Globally Disabled" in the Port State.

Port	Admin State	Port State	Last Source	Last ID	QoS Class	Port VLAN ID
1	Force Authorized	Globally Disabled				
2	Force Authorized	Globally Disabled				
3	Force Authorized	Globally Disabled				
4	Force Authorized	Globally Disabled				
5	Force Authorized	Globally Disabled				
6	Force Authorized	Globally Disabled				
7	Force Authorized	Globally Disabled				
8	Force Authorized	Globally Disabled				
9	Force Authorized	Globally Disabled				
10	Force Authorized	Globally Disabled				
11	Force Authorized	Globally Disabled				
12	Force Authorized	Globally Disabled				

Parameter description:

Port

The switch port number. Click to navigate to detailed NAS statistics for this port.

Admin State

The port's current administrative state. Refer to NAS Admin State for a description of possible values.

Port State

The current state of the port. Refer to NAS Port State for a description of the individual states.

Last Source

The source MAC address carried in the most recently received EAPOL frame for EAPOL-based authentication, and the most recently received frame from a new client for MAC-based authentication.

Last ID

The user name (supplicant identity) carried in the most recently received Response Identity EAPOL frame for EAPOL-based authentication, and the source MAC address from the most recently received frame from a new client for MAC-based authentication.

QoS Class

QoS Class assigned to the port by the RADIUS server if enabled.

Port VLAN ID

The VLAN ID that NAS has put the port in. The field is blank, if the Port VLAN ID is not overridden by NAS.

If the VLAN ID is assigned by the RADIUS server, "(RADIUS-assigned)" is appended to the VLAN ID. Read more about RADIUS-assigned VLANs [here](#).

If the port is moved to the Guest VLAN, "(Guest)" is appended to the VLAN ID. Read more about Guest VLANs [here](#).

3-5.3 Port Status

The section describes to provides detailed NAS statistics for a specific switch port running EAPOL-based IEEE 802.1X authentication.

Web Interface

To configure a NAS Port Status Configuration in the web interface:

1. Specify Port which want to check.
2. Checked "Auto-reflash".



Parameter description:

Port State

Admin State

The port's current administrative state. Refer to NAS Admin State for a description of possible values.

Port State

The current state of the port. Refer to NAS Port State for a description of the individual states.

QoS Class

The QoS class assigned by the RADIUS server. The field is blank if no QoS class is assigned.

Port VLAN ID

The VLAN ID that NAS has put the port in. The field is blank, if the Port VLAN ID is not overridden by NAS.

If the VLAN ID is assigned by the RADIUS server, "(RADIUS-assigned)" is appended to the VLAN ID. Read more about RADIUS-assigned VLANs here.

If the port is moved to the Guest VLAN, "(Guest)" is appended to the VLAN ID. Read more about Guest VLANs here.

Port Counters

EAPOL Counters

These supplicant frame counters are available for the following administrative states:

- Force Authorized
- Force Unauthorized
- Port-based 802.1X
- Single 802.1X
- Multi 802.1X

Backend Server Counters

These backend (RADIUS) frame counters are available for the following administrative states:

- Port-based 802.1X
- Single 802.1X
- Multi 802.1X
- MAC-based Auth.

Last Supplicant/Client Info

Information about the last supplicant/client that attempted to authenticate. This information is available for the following administrative states:

- Port-based 802.1X
- Single 802.1X
- Multi 802.1X
- MAC-based Auth.

Selected Counters

Selected Counters

The Selected Counters table is visible when the port is in one of the following administrative states:

- Multi 802.1X
- MAC-based Auth.

The table is identical to and is placed next to the Port Counters table, and will be empty if no MAC address is currently selected. To populate the table, select one of the attached MAC Addresses from the table below.

Attached MAC Addresses

Identity

Shows the identity of the supplicant, as received in the Response Identity EAPOL frame.

Clicking the link causes the supplicant's EAPOL and Backend Server counters to be shown in the Selected Counters table. If no supplicants are attached, it shows No supplicants attached.

This column is not available for MAC-based Auth.

MAC Address

For Multi 802.1X, this column holds the MAC address of the attached supplicant. For MAC-based Auth., this column holds the MAC address of the attached client.

Clicking the link causes the client's Backend Server counters to be shown in the Selected Counters table. If no clients are attached, it shows No clients attached.

VLAN ID

This column holds the VLAN ID that the corresponding client is currently secured through the Port Security module.

State

The client can either be authenticated or unauthenticated. In the authenticated state, it is allowed to forward frames on the port, and in the unauthenticated state, it is blocked. As long as the backend server hasn't successfully authenticated the client, it is unauthenticated. If an authentication fails for one or the other reason, the client will remain in the unauthenticated state for Hold Time seconds.

Last Authentication

Shows the date and time of the last authentication of the client (successful as well as unsuccessful).

3-6 AAA

This section shows you to use an AAA (Authentication, Authorization, Accounting) server to provide access control to your network. The AAA server can be a TACACS+ or RADIUS server to create and manage objects that contain settings for using AAA servers.

3-6.1 Configuration

This section describes how to configure AAA setting of TACACS+ or RADIUS server.

Web Interface

To configure a Common Configuration of AAA in the web interface:

1. Set Timeout (Default is 15 seconds).
2. Set Dead Time (Default is 300 seconds).

To configure a TACACS+ Authorization and Accounting Configuration of AAA in the web interface:

1. Select "Enabled" in the Authorization.
2. Select "Enabled" in the Failback to Local Authorization.
3. Select "Enabled" in the Account.

To configure a RADIUS Authentication Server Configuration of AAA in the web interface:

1. Check "Enabled".
2. Specify IP address or Hostname for Radius Server.
3. Specify Authentication Port for Radius Server (Default is 1812).
4. Specify the Secret with Radius Server.

To configure a RADIUS Accounting Server Configuration of AAA in the web interface:

1. Check "Enabled".
2. Specify IP address or Hostname for Radius Server.
3. Specify Accounting Port for Radius Server (Default is 1813).
4. Specify the Secret with Radius Server.

To configure a TACACS+ Authentication Server Configuration of AAA in the web interface:

1. Check "Enabled".
2. Specify IP address or Hostname for TACACS+ Server.
3. Specify Authentication Port for TACACS+ Server (Default is 49).
4. Specify the Secret with TACACS+ Server.

Authentication Server Configuration

Common Server Configuration

Timeout: 15 seconds
Dead Time: 300 seconds

TACACS+ Authorization and Accounting Configuration

Authorization: Disabled
Fallback to Local Authorization: Disabled
Accounting: Disabled

RADIUS Authentication Server Configuration

#	Enabled	IP Address/Hostname	Port	Secret
1	<input type="checkbox"/>		1812	
2	<input type="checkbox"/>		1812	
3	<input type="checkbox"/>		1812	
4	<input type="checkbox"/>		1812	
5	<input type="checkbox"/>		1812	

RADIUS Accounting Server Configuration

#	Enabled	IP Address/Hostname	Port	Secret
1	<input type="checkbox"/>		1813	
2	<input type="checkbox"/>		1813	
3	<input type="checkbox"/>		1813	
4	<input type="checkbox"/>		1813	
5	<input type="checkbox"/>		1813	

TACACS+ Authentication Server Configuration

#	Enabled	IP Address/Hostname	Port	Secret
1	<input type="checkbox"/>		49	
2	<input type="checkbox"/>		49	
3	<input type="checkbox"/>		49	
4	<input type="checkbox"/>		49	
5	<input type="checkbox"/>		49	

Save Reset

Parameter description:

Timeout

The Timeout, which can be set to a number between 3 and 3600 seconds, is the maximum time to wait for a reply from a server. If the server does not reply within this timeframe, we will consider it to be dead and continue with the next enabled server (if any). RADIUS servers are using the UDP protocol, which is unreliable by design. In order to cope with lost frames, the timeout interval is divided into 3 subintervals of equal length. If a reply is not received within the subinterval, the request is transmitted again. This algorithm causes the RADIUS server to be queried up to 3 times before it is considered to be dead.

Dead Time

The Dead Time, which can be set to a number between 0 and 3600 seconds, is the period during which the switch will not send new requests to a server that has failed to respond to a previous request. This will stop the switch from continually trying to contact a server that it has already determined as dead. Setting the Dead Time to a value greater than 0 (zero) will enable this feature, but only if more than one server has been configured.

RADIUS Authentication Server Configuration

The table has one row for each RADIUS Authentication Server and a number of columns, which are:

#

The RADIUS Authentication Server number for which the configuration below applies.

Enabled

Enable the RADIUS Authentication Server by checking this box.

IP Address/Hostname

The IP address or hostname of the RADIUS Authentication Server. IP address is expressed in dotted decimal notation.

Port

The UDP port to use on the RADIUS Authentication Server. If the port is set to 0 (zero), the default port (1812) is used on the RADIUS Authentication Server.

Secret

The secret - up to 29 characters long - shared between the RADIUS Authentication Server and the switch stack.

RADIUS Accounting Server Configuration

The table has one row for each RADIUS Accounting Server and a number of columns, which are:

#

The RADIUS Accounting Server number for which the configuration below applies.

Enabled

Enable the RADIUS Accounting Server by checking this box.

IP Address/Hostname

The IP address or hostname of the RADIUS Accounting Server. IP address is expressed in dotted decimal notation.

Port

The UDP port to use on the RADIUS Accounting Server. If the port is set to 0 (zero), the default port (1813) is used on the RADIUS Accounting Server.

Secret

The secret - up to 29 characters long - shared between the RADIUS Accounting Server and the switch stack.

TACACS+ Authentication Server Configuration

The table has one row for each TACACS+ Authentication Server and a number of columns, which are:

#

The TACACS+ Authentication Server number for which the configuration below applies.

Enabled

Enable the TACACS+ Authentication Server by checking this box.

IP Address/Hostname

The IP address or hostname of the TACACS+ Authentication Server. IP address is expressed in dotted decimal notation.

Port

The TCP port to use on the TACACS+ Authentication Server. If the port is set to 0 (zero), the default port (49) is used on the TACACS+ Authentication Server.

Secret

The secret - up to 29 characters long - shared between the TACACS+ Authentication Server and the switch stack.

3-6.2 Radius Overview

This section shows you an overview of the RADIUS Authentication and Accounting servers status to ensure the function is workable.

Web Interface

To configure a RADIUS Overview Configuration in the web interface:

1. Checked "Auto-reflash".

#	IP Address	Status
1	0.0.0.1812	Disabled
2	0.0.0.1812	Disabled
3	0.0.0.1812	Disabled
4	0.0.0.1812	Disabled
5	0.0.0.1812	Disabled

#	IP Address	Status
1	0.0.0.1813	Disabled
2	0.0.0.1813	Disabled
3	0.0.0.1813	Disabled
4	0.0.0.1813	Disabled
5	0.0.0.1813	Disabled

Parameter description:

#

The RADIUS server number. Click to navigate to detailed statistics for this server.

IP Address

The IP address and UDP port number (in <IP Address>:<UDP Port> notation) of this server.

State

The current state of the server. This field takes one of the following values:
Disabled: The server is disabled.

Not Ready: The server is enabled, but IP communication is not yet up and running.

Ready: The server is enabled, IP communication is up and running, and the RADIUS module is ready to accept access attempts.

Dead (X seconds left): Access attempts were made to this server, but it did not reply within the configured timeout. The server has temporarily been disabled, but will get re-enabled when the dead-time expires. The number of seconds left before this occurs is displayed in parentheses. This state is only reachable when more than one server is enabled.

RADIUS Accounting Servers

#

The RADIUS server number. Click to navigate to detailed statistics for this server.

IP Address

The IP address and UDP port number (in <IP Address>:<UDP Port> notation) of this server.

State

The current state of the server. This field takes one of the following values:

Disabled: The server is disabled.

Not Ready: The server is enabled, but IP communication is not yet up and running.

Ready: The server is enabled, IP communication is up and running, and the RADIUS module is ready to accept accounting attempts.

Dead (X seconds left): Accounting attempts were made to this server, but it did not reply within the configured timeout. The server has temporarily been disabled, but will get re-enabled when the dead-time expires. The number of seconds left before this occurs is displayed in parentheses. This state is only reachable when more than one server is enabled.

3-6.3 Radius Details

This section shows you an detailed statistics of the RADIUS Authentication and Accounting servers. The statistics map closely to those specified in RFC4668 - RADIUS Authentication Client MIB.

Web Interface

To configure a RADIUS Details Configuration in the web interface:

1. Specify Port which want to check.
2. Checked "Auto-reflash".

The screenshot displays two sections of statistics for a RADIUS server. The top section is for authentication on port 1812, and the bottom section is for accounting on port 1813. Both sections include tables for received and transmitted packets, and other information like state and round-trip time.

RADIUS Authentication Statistics for Server #1 (0.0.0.0:1812)

Receive Packets		Transmit Packets	
Access Accepts	0	Access Requests	0
Access Rejects	0	Access Retransmissions	0
Access Challenges	0	Pending Requests	0
Malformed Access Responses	0	Timeouts	0
Bad Authenticators	0		
Unknown Types	0		
Packets Dropped	0		

Other Info

State	Disabled
Round-Trip Time	0 ms

RADIUS Accounting Statistics for Server #1 (0.0.0.0:1813)

Receive Packets		Transmit Packets	
Responses	0	Requests	0
Malformed Responses	0	Retransmissions	0
Bad Authenticators	0	Pending Requests	0
Unknown Types	0	Timeouts	0
Packets Dropped	0		

Other Info

State	Disabled
Round-Trip Time	0 ms

Server #1 | Auto-refresh | Refresh | Clear

3-7 Port Security

This section shows you to to configure the Port Security settings of the Switch. You can use the Port Security feature to restrict input to an interface by limiting and identifying MAC addresses.

3-7.1 Limit Control

This section shows you to to configure the Port Security settings of the Switch. You can use the Port Security feature to restrict input to an interface by limiting and identifying MAC addresses.

Web Interface

To configure a System Configuration of Limit Control in the web interface:

1. Select “Enabled” in the Mode of System Configuration.
2. Checked Aging Enabled.
3. Set Aging Period (Default is 3600 seconds).

To configure a Port Configuration of Limit Control in the web interface:

1. Select “Enabled” in the Mode of Port Configuration.
2. Specify the maximum number of MAC addresses in the Limit of Port Configuration.
3. Set Ation (Trap, Shutdown, Trap & Shutdown)
4. Click Save.

Port Security Limit Control Configuration

System Configuration

Mode: Disabled
Aging Enabled:
Aging Period: 3600 seconds

Port Configuration

Port	Mode	Limit	Action	State	Re-open
1	Disabled	4	None	Disabled	Reopen
2	Disabled	4	None	Disabled	Reopen
3	Disabled	4	None	Disabled	Reopen
4	Disabled	4	None	Disabled	Reopen
5	Disabled	4	None	Disabled	Reopen
6	Disabled	4	None	Disabled	Reopen
7	Disabled	4	None	Disabled	Reopen
8	Disabled	4	None	Disabled	Reopen

Parameter description:

System Configuration

Mode

Indicates if Limit Control is globally enabled or disabled on the switchstack. If globally disabled, other modules may still use the underlying functionality, but limit checks and corresponding actions are disabled.

Aging Enabled

If checked, secured MAC addresses are subject to aging as discussed under Aging Period .

Aging Period

If Aging Enabled is checked, then the aging period is controlled with this input. If other modules are using the underlying port security for securing MAC addresses, they may have other requirements to the aging period. The underlying port security will use the shorter requested aging period of all modules that use the functionality.

The Aging Period can be set to a number between 10 and 10,000,000 seconds.

To understand why aging may be desired, consider the following scenario: Suppose an end-host is connected to a 3rd party switch or hub, which in turn is connected to a port on this switch on which Limit Control is enabled. The end-host will be allowed to forward if the limit is not exceeded. Now suppose that the end-host logs off or powers down. If it wasn't for aging, the end-host would still take up resources on this switch and will be allowed to forward. To overcome this situation, enable aging. With aging enabled, a timer is started once the end-host gets secured. When the timer expires, the switch starts looking for frames from the end-host, and if such frames are not seen within the next Aging Period, the end-host is assumed to be disconnected, and the corresponding resources are freed on the switch.

Port Configuration

The table has one row for each port on the selected switch in the stack and a number of columns, which are:

Port

The port number to which the configuration below applies.

Mode

Controls whether Limit Control is enabled on this port. Both this and the Global Mode must be set to Enabled for Limit Control to be in effect. Notice that other modules may still use the underlying port security features without enabling Limit Control on a given port.

Limit

The maximum number of MAC addresses that can be secured on this port. This number cannot exceed 1024. If the limit is exceeded, the corresponding action is taken.

The stackswitch is "born" with a total number of MAC addresses from which all ports draw whenever a new MAC address is seen on a Port Security-enabled port. Since all ports draw from the same pool, it may happen that a configured maximum cannot be granted, if the remaining ports have already used all available MAC addresses.

Action

If Limit is reached, the switch can take one of the following actions:

None: Do not allow more than Limit MAC addresses on the port, but take no further action.

Trap: If Limit + 1 MAC addresses is seen on the port, send an SNMP trap. If Aging is disabled, only one SNMP trap will be sent, but with Aging enabled, new SNMP traps will be sent everytime the limit gets exceeded.

Shutdown: If Limit + 1 MAC addresses is seen on the port, shut down the port. This implies that all secured MAC addresses will be removed from the port, and no new address will be learned. Even if the link is physically disconnected and reconnected on the port (by disconnecting the cable), the port will remain shut down. There are three ways to re-open the port:

- 1) Boot the stack or elect a new masterthe switch,
- 2) Disable and re-enable Limit Control on the port or the stackswitch,
- 3) Click the Reopen button.

Trap & Shutdown: If Limit + 1 MAC addresses is seen on the port, both the "Trap" and the "Shutdown" actions described above will be taken.

State

This column shows the current state of the port as seen from the Limit Control's point of view. The state takes one of four values:

Disabled: Limit Control is either globally disabled or disabled on the port.

Ready: The limit is not yet reached. This can be shown for all actions.

Limit Reached: Indicates that the limit is reached on this port. This state can only be shown if Action is set to None or Trap.

Shutdown: Indicates that the port is shut down by the Limit Control module.

This state can only be shown if Action is set to Shutdown or Trap & Shutdown.

Re-open Button

If a port is shutdown by this module, you may reopen it by clicking this button, which will only be enabled if this is the case. For other methods, refer to Shutdown in the Action section.

Note that clicking the reopen button causes the page to be refreshed, so non-committed changes will be lost

3-7.2 Switch Status

This section shows the Port Security status. Port Security is a module with no direct configuration. Configuration comes indirectly from other modules - the user modules. When a user module has enabled port security on a port, the port is set-up for software-based learning. In this mode, frames from unknown MAC addresses are passed on to the port security module, which in turn asks all user modules whether to allow this new MAC address to forward or block it. For a MAC address to be set in the forwarding state, all enabled user modules must unanimously agree on allowing the MAC address to forward. If only one chooses to block it, it will be blocked until that user module decides otherwise.

The status page is divided into two sections - one with a legend of user modules and one with the actual port status.

Web Interface

To configure a Port Security Switch Status Configuration in the web interface:

1. Checked "Auto-reflash"

Port Security Switch Status Auto-refresh Refresh

User Module Legend

User Module Name	Abbr
Limit Control	L
802.1X	8
DHCP Snooping	D
Voice VLAN	V

Port Status

Port	Users	State	MAC Count	
			Current	Limit
1	----	Disabled	-	-
2	----	Disabled	-	-
3	----	Disabled	-	-
4	----	Disabled	-	-
5	----	Disabled	-	-
6	----	Disabled	-	-
7	----	Disabled	-	-
8	----	Disabled	-	-
9	----	Disabled	-	-
10	----	Disabled	-	-
11	----	Disabled	-	-
12	----	Disabled	-	-
13	----	Disabled	-	-
14	----	Disabled	-	-

Parameter description:

User Module Legend

The legend shows all user modules that may request Port Security services.

User Module Name

The full name of a module that may request Port Security services.

Abbr

A one-letter abbreviation of the user module. This is used in the Users column in the port status table.

Port Status

The table has one row for each port on the selected switch in the stack and a number of columns, which are:

Port

The port number for which the status applies. Click the port number to see the status for this particular port.

Users

Each of the user modules has a column that shows whether that module has enabled Port Security or not. A '-' means that the corresponding user module is not enabled, whereas a letter indicates that the user module abbreviated by that letter (see Abbr) has enabled port security.

State

Shows the current state of the port. It can take one of four values:

Disabled: No user modules are currently using the Port Security service.

Ready: The Port Security service is in use by at least one user module, and is awaiting frames from unknown MAC addresses to arrive.

Limit Reached: The Port Security service is enabled by at least the Limit Control user module, and that module has indicated that the limit is reached and no more MAC addresses should be taken in.

Shutdown: The Port Security service is enabled by at least the Limit Control user module, and that module has indicated that the limit is exceeded. No MAC addresses can be learned on the port until it is administratively re-opened on the Limit Control configuration Web-page.

MAC Count (Current, Limit)

The two columns indicate the number of currently learned MAC addresses (forwarding as well as blocked) and the maximum number of MAC addresses that can be learned on the port, respectively.

If no user modules are enabled on the port, the Current column will show a dash (-).

If the Limit Control user module is not enabled on the port, the Limit column will show a dash (-).

Indicates the number of currently learned MAC addresses (forwarding as well as blocked) on the port. If no user modules are enabled on the port, a dash (-) will be shown.

3-7.3 Port Status

This section shows the MAC addresses secured by the Port Security module. Port Security is a module with no direct configuration. Configuration comes indirectly from other modules - the user modules. When a user module has enabled port security on a port, the port is set-up for software-based learning. In this mode, frames from unknown MAC addresses are passed on to the port security module, which in turn asks all user modules whether to allow this new MAC address to forward or block it. For a MAC address to be set in the forwarding state, all enabled user modules must unanimously agree on allowing the MAC address to forward. If only one chooses to block it, it will be blocked until that user module decides otherwise.

Web Interface

To configure a Port Security Switch Status Configuration in the web interface:

1. Specify the Port which you want to monitor
2. Checked "Auto-reflash".

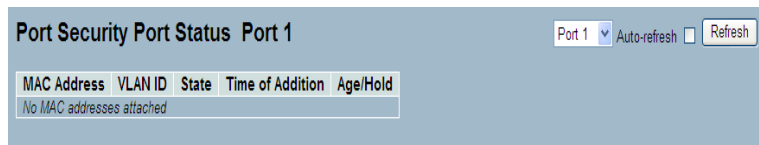

Parameter description:

MAC Address & VLAN ID

The MAC address and VLAN ID that is seen on this port. If no MAC addresses are learned, a single row stating "No MAC addresses attached" is displayed.

State

Indicates whether the corresponding MAC address is blocked or forwarding. In the blocked state, it will not be allowed to transmit or receive traffic.

Time of Addition

Shows the date and time when this MAC address was first seen on the port.

Age/Hold

If at least one user module has decided to block this MAC address, it will stay in the blocked state until the hold time (measured in seconds) expires. If all user modules have decided to allow this MAC address to forward, and aging is enabled, the Port Security module will periodically check that this MAC address still forwards traffic. If the age period (measured in seconds) expires and no frames have been seen, the MAC address will be removed from the MAC table. Otherwise a new age period will begin.

If aging is disabled or a user module has decided to hold the MAC address indefinitely, a dash (-) will be shown.

3-8 Access Management

This section shows you to configure access management table of the Switch including HTTP/HTTPS, SNMP, and TELNET/SSH. You can manage the Switch over an Ethernet LAN, or over the Internet.

3-8.1 Configuration

This section shows you how to configure access management table of the Switch. The maximum entry number is 16. If the application's type match any one of the access management entries, it will allow access to the switch.

Web Interface

To configure a Access Management Configuration in the web interface:

1. Select "Enabled" in the Mode of Access Management Configuration.
2. Click "Add new entry".
3. Specify the Start IP Address, End IP Address.
4. Checked Access Managemnet method (HTTP/HTTPS, SNMP, and TELNET/SSH) in the entry.
5. Click Save.

Access Management Configuration

Mode

Delete	Start IP Address	End IP Address	HTTP/HTTPS	SNMP	TELNET/SSH
--------	------------------	----------------	------------	------	------------

Parameter description:

Mode

Indicates the access management mode operation. Possible modes are:

Enabled: Enable access management mode operation.

Disabled: Disable access management mode operation.

Delete

Check to delete the entry. It will be deleted during the next save.

Start IP address

Indicates the start IP address for the access management entry.

End IP address

Indicates the end IP address for the access management entry.

HTTP/HTTPS

Indicates that the host can access the switch from HTTP/HTTPS interface if the host IP address matches the IP address range provided in the entry.

SNMP

Indicates that the host can access the switch from SNMP interface if the host IP address matches the IP address range provided in the entry.

TELNET/SSH

Indicates that the host can access the switch from TELNET/SSH interface if the host IP address matches the IP address range provided in the entry.

3-8.2 Configuration

This section shows you an detailed statistics of the Access Management including HTTP, HTTPS, SSH, TELNET, ans SSH.

Web Interface

To configure an Assess ManagementConfiguration in the web interface:

1. Checked "Auto-reflash".

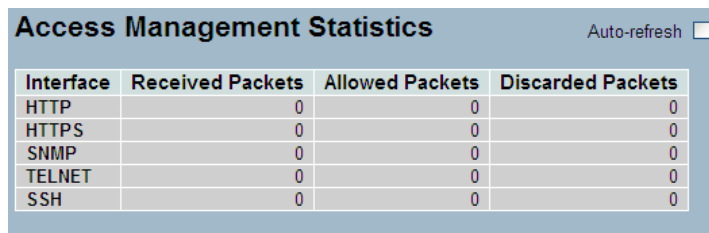

Interface	Received Packets	Allowed Packets	Discarded Packets
HTTP	0	0	0
HTTPS	0	0	0
SNMP	0	0	0
TELNET	0	0	0
SSH	0	0	0

Parameter description:

Interface

The interface type through which the remote host can access the switch.

Received Packets

Number of received packets from the interface when access management mode is enabled.

Allowed Packets

Number of allowed packets from the interface when access management mode is enabled

Discarded Packets.

Number of discarded packets from the interface when access management mode is enabled.

3-9 SSH

This section shows you to use SSH (Secure SHell) to securely access the Switch. SSH is a secure communication protocol that combines authentication and data encryption to provide secure encrypted communication.

Web Interface

To configure a SSH Configuration in the web interface:

1. Select "Enabled" in the Mode of SSH Configuration.
2. Click Save.

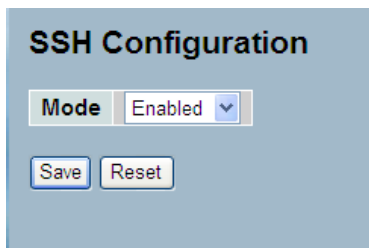

The image shows a web interface for SSH Configuration. It has a title "SSH Configuration" in bold. Below the title is a "Mode" label followed by a dropdown menu showing "Enabled" with a downward arrow. At the bottom of the form are two buttons: "Save" and "Reset".

Parameter description:

Mode

Indicates the SSH mode operation. Possible modes are:

Enabled: Enable SSH mode operation.

Disabled: Disable SSH mode operation.

3-10 HTTPS

This section shows you how to use HTTPS to securely access the Switch. HTTPS is a secure communication protocol that combines authentication and data encryption to provide secure encrypted communication via the browser.

Web Interface

To configure a HTTPS Configuration in the web interface:

1. Select “Enabled” in the Mode of HTTPS Configuration.
2. Select “Enabled” in the Automatic Redirect of HTTPS Configuration.
3. Click Save.

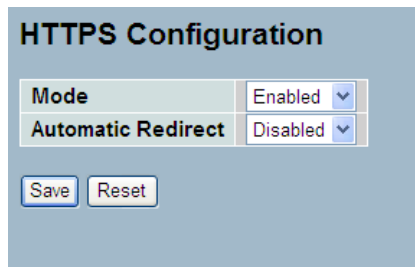

HTTPS Configuration	
Mode	Enabled
Automatic Redirect	Disabled
<input type="button" value="Save"/> <input type="button" value="Reset"/>	

Parameter description:

Mode

Indicates the HTTPS mode operation. Possible modes are:

Enabled: Enable HTTPS mode operation.

Disabled: Disable HTTPS mode operation.

Automatic Redirect

Indicates the HTTPS redirect mode operation. Automatically redirect web browser to HTTPS when HTTPS mode is enabled. Possible modes are:

Enabled: Enable HTTPS redirect mode operation.

Disabled: Disable HTTPS redirect mode operation.

3-11 Auth Method

This page shows how to configure a user with authenticated when he logs into the switch via one of the management client interfaces.

Web Interface

To configure a Authentication Method Configuration in the web interface:

1. Specify the Client (console, telnet, ssh, web) which you want to monitor.
2. Specify the Authentication Method (none,local, radius, tacacs+)
3. Checked Fallback.
4. Click Save.

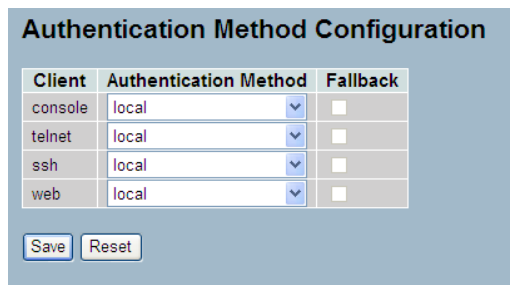

Client	Authentication Method	Fallback
console	local	<input type="checkbox"/>
telnet	local	<input type="checkbox"/>
ssh	local	<input type="checkbox"/>
web	local	<input type="checkbox"/>

Save Reset

Parameter description:

Client

The management client for which the configuration below applies.

Authentication Method

Authentication Method can be set to one of the following values:

- none : authentication is disabled and login is not possible.
- local : use the local user database on the switch stack for authentication.
- radius : use a remote RADIUS server for authentication.
- tacacs+ : use a remote TACACS+ server for authentication.

Fallback

Enable fallback to local authentication by checking this box.

If none of the configured authentication servers are alive, the local user database is used for authentication.

This is only possible if the Authentication Method is set to a value other than 'none' or 'local'.

4. Maintenance

This chapter describes all of the switch Maintenance configuration tasks to enhance the performance of local network including Restart Device, Firmware upgrade, Save/Restore, Import/Export, and Diagnostics.

4-1 Restart Device

This section describes how to restart switch for any maintenance needs. Any configuration files or scripts that you saved in the switch should still be available afterwards.

Web Interface

To configure a Restart Device Configuration in the web interface:

1. Click Restart Device.
2. Click Yes.

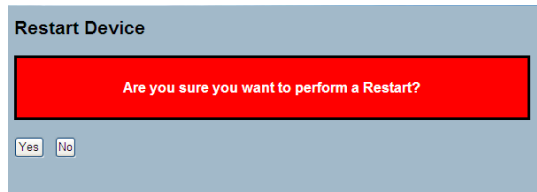

Parameter description:

Restart Device

You can restart the stack switch on this page. After restart, the stack switch will boot normally.

4-2 Firmware Upgrade

This section describes how to upgrade Firmware. The Switch can be enhanced with more value-added functions by installing firmware upgrades.

Web Interface

To configure a Firmware Upgrade Configuration in the web interface:

1. Click Browser to select firmware in you device.
2. Click Upload.

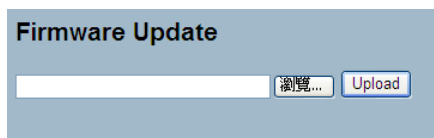

Parameter description:

This page facilitates an update of the firmware controlling the stack. switch.

Uploading software will update all managed switches in the stack.

Force Cool Restart

Uncheck "Force Cool Restart" if you want to perform a warm restart of the stack switch after the software upload.

Check "Force Cool Restart" if you want to simulate a power-on (cold restart) of the stack switch after the software upload.

Warning: Forcing a cool restart will affect the traffic going through the stack. switch.

to the location of a software image and click .

After the software image is uploaded, a page announces that the firmware update is initiated. After about a minute, the firmware is updated and all managed switches in the stack restart. the switch restarts.

Warning: While the firmware is being updated, Web access appears to be defunct. The front LED flashes Green/Off with a frequency of 10 Hz while the firmware update is in progress. Do not restart or power off the device at this time or the switch may fail to function afterwards

4-3 Save / Restore

This section describes how to save and restore the Switch configuration including reset to Factory Defaults, Save Start, Save Users, Restore Users for any maintenance needs.

4-3.1 Factory Defaults

This section describes how to reset the Switch configuration to Factory Defaults. Any configuration files or scripts will recover to factory default values.

Web Interface

To configure a Factory Defaults Configuration in the web interface:

1. Click Factory Defaults.
2. Click Yes.



Parameter description:

You can reset the configuration of the stack switch on this page. Only the IP configuration is retained.

The new configuration is available immediately, which means that no restart is necessary.

: Click to reset the configuration to Factory Defaults.

: Click to return to the Port State page without resetting the configuration.

4-3.2 Save Start

This section describes how to save the Switch Start configuration. Any current configuration files will be saved as XML format.

Web Interface

To configure a Save Start Configuration in the web interface:

1. Click Save Start.
2. Click Yes.

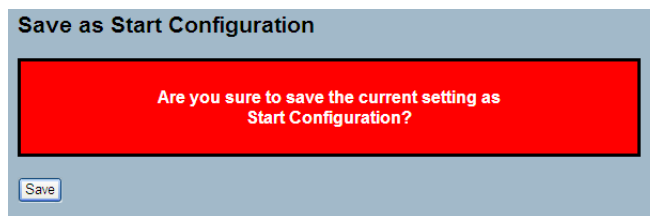

Parameter description:

You can save/view or load the switch configuration. The configuration file is in XML format with a hierarchy of tags

4-3.3 Save User

This section describes how to save users information. Any current configuration files will be saved as XML format.

Web Interface

To configure a Save User Configuration in the web interface:

1. Click Save User.
2. Click Yes.

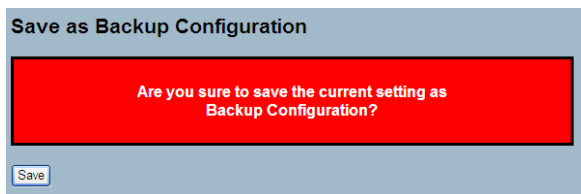

Parameter description:

You can save/view or load the switch configuration. The configuration file is in XML format with a hierarchy of tags

4-3.4 Restore User

This section describes how to restore users information back to the switch. Any current configuration files will be restored via XML format.

Web Interface

To configure a Restore User Configuration in the web interface:

1. Click Restore User.
2. Click Yes.

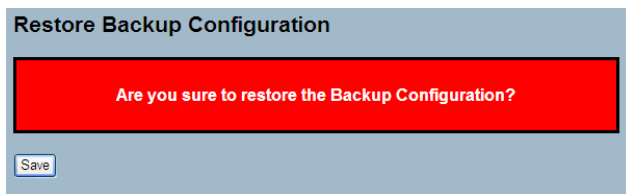

Parameter description:

You can save/view or load the switch configuration. The configuration file is in XML format with a hierarchy of tags

4-4 Export / Import

This section describes how to export and import the Switch configuration. Any current configuration files will be exported as XML format.

4-4.1 Export Config

This section describes to export the Swith Configuration for maintenance needs. Any current configuration files will be exported as XML format.

Web Interface

To configure a Export Config Configuration in the web interface:

1. Chick Save configuration.
2. Save the file in your device.



Parameter description:

You can save/view or load the switch configuration. The configuration file is in XML format with a hierarchy of tags

4-4.2 Import Config

This section describes to export the Switch Configuration for maintenance needs. Any current configuration files will be exported as XML format.

Web Interface

To configure an Import Config Configuration in the web interface:

1. Click Browser to select the config file in you device.
2. Click Upload.



Parameter description:

You can save/view or load the switch configuration. The configuration file is in XML format with a hierarchy of tags

4-5 Diagnostics

This section provides a set of basic system diagnosis. It let users know that whether the system is health or needs to be fixed. The basic system check includes ICMP Ping, ICMPv6, and VeriPHY Cable Diagnostics.

4-5.1 Ping

This section allows you to issue ICMP PING packets to troubleshoot IPv6 connectivity issues.

Web Interface

To configure an ICMP PING Configuration in the web interface:

1. Specify ICMP PING IP Address.
2. Specify ICMP PING Size.
3. Click Start.

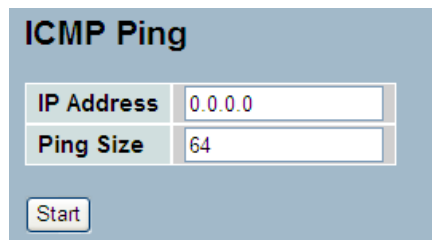

ICMP Ping	
IP Address	0.0.0.0
Ping Size	64
<input type="button" value="Start"/>	

Parameter description:

After you press , 5 ICMP packets are transmitted, and the sequence number and roundtrip time are displayed upon reception of a reply. The page refreshes automatically until responses to all packets are received, or until a timeout occurs.

```
PING6 server ::10.10.132.20
```

```
64 bytes from ::10.10.132.20: icmp_seq=0, time=0ms
```

```
64 bytes from ::10.10.132.20: icmp_seq=1, time=0ms
```

```
64 bytes from ::10.10.132.20: icmp_seq=2, time=0ms
```

```
64 bytes from ::10.10.132.20: icmp_seq=3, time=0ms
```

```
64 bytes from ::10.10.132.20: icmp_seq=4, time=0ms
```

```
Sent 5 packets, received 5 OK, 0 bad
```

Link OAM MIB Retrieve

This page allows you to retrieve the Local or Remote OAM MIB variable data on a particular port. Select the appropriate Radio button to retrieve the content of interest, Enter the Port number for the switch. Click on Start to retrieve the content.

4-5.2 Ping6

This section allows you to issue ICMPv6 PING packets to troubleshoot IPv6 connectivity issues.

Web Interface

To configure an ICMPv6 PING Configuration in the web interface:

1. Specify ICMPv6 PING IP Address.
2. Specify ICMPv6 PING Size.
3. Click Start.

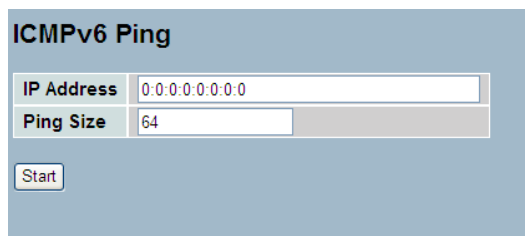

The screenshot shows a web interface titled "ICMPv6 Ping". It contains two input fields: "IP Address" with the value "0:0:0:0:0:0:0:0" and "Ping Size" with the value "64". Below these fields is a "Start" button.

Parameter description:

After you press , 5 ICMPv6 packets are transmitted, and the sequence number and roundtrip time are displayed upon reception of a reply. The page refreshes automatically until responses to all packets are received, or until a timeout occurs.

PING server 10.10.132.20

64 bytes from 10.10.132.20: icmp_seq=0, time=0ms

64 bytes from 10.10.132.20: icmp_seq=1, time=0ms

64 bytes from 10.10.132.20: icmp_seq=2, time=0ms

64 bytes from 10.10.132.20: icmp_seq=3, time=0ms

64 bytes from 10.10.132.20: icmp_seq=4, time=0ms

Sent 5 packets, received 5 OK, 0 bad

You can configure the following properties of the issued ICMP packets:

IP Address

The destination IP Address.

Ping Size

The payload size of the ICMP packet. Values range from 8 bytes to 1400 bytes.

4-5.3 VeriPHY

This section is used for running the VeriPHY Cable Diagnostics. Press to run the diagnostics. This will take approximately 5 seconds. If all ports are selected, this can take approximately 15 seconds. When completed, the page refreshes automatically, and you can view the cable diagnostics results in the cable status table. Note that VeriPHY is only accurate for cables of length 7 -140 meters. 10 and 100 Mbps ports will be linked down while running VeriPHY. Therefore, running VeriPHY on a 10 or 100 Mbps management port will cause the switch to stop responding until VeriPHY is complete.

Web Interface

To configure a VeriPHY Cable Diagnostics Configuration in the web interface:

1. Specify Port which want to check.
2. Click Start.

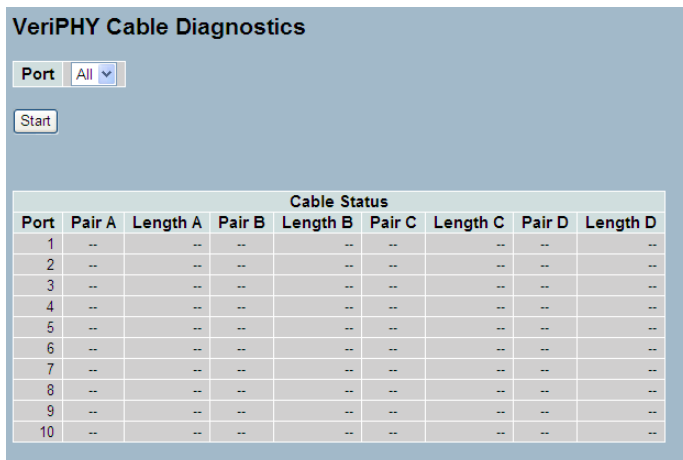

VeriPHY Cable Diagnostics

Port: All

Start

Cable Status								
Port	Pair A	Length A	Pair B	Length B	Pair C	Length C	Pair D	Length D
1	--	--	--	--	--	--	--	--
2	--	--	--	--	--	--	--	--
3	--	--	--	--	--	--	--	--
4	--	--	--	--	--	--	--	--
5	--	--	--	--	--	--	--	--
6	--	--	--	--	--	--	--	--
7	--	--	--	--	--	--	--	--
8	--	--	--	--	--	--	--	--
9	--	--	--	--	--	--	--	--
10	--	--	--	--	--	--	--	--

Parameter description:

Port

The port where you are requesting VeriPHY Cable Diagnostics.

Cable Status

Port: Port number.

Pair: The status of the cable pair.

Length: The length (in meters) of the cable pair.

B. Glossary of Web-based Management

A

ACE

ACE is an acronym for Access Control Entry. It describes access permission associated with a particular ACE ID.

There are three ACE frame types (Ethernet Type, ARP, and IPv4) and two ACE actions (permit and deny). The ACE also contains many detailed, different parameter options that are available for individual application.

ACL

ACL is an acronym for Access Control List. It is the list table of ACEs, containing access control entries that specify individual users or groups permitted or denied to specific traffic objects, such as a process or a program.

Each accessible traffic object contains an identifier to its ACL. The privileges determine whether there are specific traffic object access rights. ACL implementations can be quite complex, for example, when the ACEs are prioritized for the various situation. In networking, the ACL refers to a list of service ports or network services that are available on a host or server, each with a list of hosts or servers permitted or denied to use the service. ACL can generally be configured to control inbound traffic, and in this context, they are similar to firewalls.

There are 3 web-pages associated with the manual ACL configuration:

ACL|Access Control List: The web page shows the ACEs in a prioritized way, highest (top) to lowest (bottom). Default the table is empty. An ingress frame will only get a hit on one ACE even though there are more matching ACEs. The first matching ACE will take action (permit/deny) on that frame and a counter associated with that ACE is incremented. An ACE can be associated with a Policy, 1 ingress port, or any ingress port (the whole switch). If an ACE Policy is created then that Policy can be associated with a group of ports under the "Ports" web-page. There are number of parameters that can be configured with an ACE. Read the Web page help text to get further information for each of them. The maximum number of ACEs is 64.

ACL|Ports: The ACL Ports configuration is used to assign a Policy ID to an ingress port. This is useful to group ports to obey the same traffic rules. Traffic Policy is created under the "Access Control List" - page. You can you also set up specific traffic properties (Action / Rate Limiter / Port copy, etc) for each ingress port. They will though only apply if the frame gets past the

ACE matching without getting matched. In that case a counter associated with that port is incremented. See the Web page help text for each specific port property.

ACL|Rate Limiters: Under this page you can configure the rate limiters. There can be 15 different rate limiters, each ranging from 1-1024K packets per seconds. Under "Ports" and "Access Control List" web-pages you can assign a Rate Limiter ID to the ACE(s) or ingress port(s).

AES

AES is an acronym for Advanced Encryption Standard. The encryption key protocol is applied in 802.11 standard to improve WLAN security. It is an encryption standard by the U.S. government, which will replace DES and 3DES. AES has a fixed block size of 128 bits and a key size of 128, 192, or 256 bits.

APS

APS is an acronym for Automatic Protection Switching. This protocol is used to secure that switching is done bidirectional in the two ends of a protection group, as defined in G.8031.

Aggregation

Using multiple ports in parallel to increase the link speed beyond the limits of a port and to increase the redundancy for higher availability.

(Also Port Aggregation, Link Aggregation).

ARP

ARP is an acronym for Address Resolution Protocol. It is a protocol that used to convert an IP address into a physical address, such as an Ethernet address. ARP allows a host to communicate with other hosts when only the Internet address of its neighbors is known. Before using IP, the host sends a broadcast ARP request containing the Internet address of the desired destination system.

ARP Inspection

ARP Inspection is a secure feature. Several types of attacks can be launched against a host or devices connected to Layer 2 networks by "poisoning" the ARP caches. This feature is used to block such attacks. Only valid ARP requests and responses can go through the switch device.

Auto-Negotiation

Auto-negotiation is the process where two different devices establish the mode of operation and the speed settings that can be shared by those devices for a link.

C

CC

CC is an acronym for Continuity Check. It is a MEP functionality that is able to detect loss of continuity in a network by transmitting CCM frames to a peer MEP.

CCM

CCM is an acronym for Continuity Check Message. It is a OAM frame transmitted from a MEP to it's peer MEP and used to implement CC functionality.

CDP

CDP is an acronym for Cisco Discovery Protocol.

D

DEI

DEI is an acronym for Drop Eligible Indicator. It is a 1-bit field in the VLAN tag.

DES

DES is an acronym for Data Encryption Standard. It provides a complete description of a mathematical algorithm for encrypting (enciphering) and decrypting (deciphering) binary coded information.

Encrypting data converts it to an unintelligible form called cipher. Decrypting cipher converts the data back to its original form called plaintext. The algorithm described in this standard specifies both enciphering and deciphering operations which are based on a binary number called a key.

DHCP

DHCP is an acronym for Dynamic Host Configuration Protocol. It is a protocol used for assigning dynamic IP addresses to devices on a network.

DHCP used by networked computers (clients) to obtain IP addresses and other parameters such as the default gateway, subnet mask, and IP addresses of DNS servers from a DHCP server.

The DHCP server ensures that all IP addresses are unique, for example, no IP address is assigned to a second client while the first client's assignment is valid (its lease has not expired). Therefore, IP address pool management is done by the server and not by a human network administrator.

Dynamic addressing simplifies network administration because the software keeps track of IP addresses rather than requiring an administrator to manage the task. This means that a new computer can be added to a network without the hassle of manually assigning it a unique IP address.

DHCP Relay

DHCP Relay is used to forward and to transfer DHCP messages between the clients and the server when they are not on the same subnet domain.

The DHCP option 82 enables a DHCP relay agent to insert specific information into a DHCP request packets when forwarding client DHCP packets to a DHCP server and remove the specific information from a DHCP reply packets when forwarding server DHCP packets to a DHCP client. The DHCP server can use this information to implement IP address or other assignment policies. Specifically the option works by setting two sub-options: Circuit ID (option 1) and Remote ID (option2). The Circuit ID sub-option is supposed to include information specific to which circuit the request came in on. The Remote ID sub-option was designed to carry information relating to the remote host end of the circuit.

The definition of Circuit ID in the switch is 4 bytes in length and the format is "vlan_id" "module_id" "port_no". The parameter of "vlan_id" is the first two bytes represent the VLAN ID. The parameter of "module_id" is the third byte for the module ID (in standalone switch it always equal 0, in stackable switch it means switch ID). The parameter of "port_no" is the fourth byte and it means the port number.

The Remote ID is 6 bytes in length, and the value is equal the DHCP relay agents MAC address.

DHCP Snooping

DHCP Snooping is used to block intruder on the untrusted ports of the switch device when it tries to intervene by injecting a bogus DHCP reply packet to a legitimate conversation between the DHCP client and server.

DNS

DNS is an acronym for Domain Name System. It stores and associates many types of information with domain names. Most importantly, DNS translates human-friendly domain names and computer hostnames into computer-friendly IP addresses. For example, the domain name www.example.com might translate to 192.168.0.1.

DoS

DoS is an acronym for Denial of Service. In a denial-of-service (DoS) attack, an attacker attempts to prevent legitimate users from accessing information or services. By targeting at network sites or network connection, an attacker may be able to prevent network users from accessing email, web sites, online accounts (banking, etc.), or other services that rely on the affected computer.

Dotted Decimal Notation

Dotted Decimal Notation refers to a method of writing IP addresses using decimal numbers and dots as separators between octets.

An IPv4 dotted decimal address has the form x.y.z.w, where x, y, z, and w

are decimal numbers between 0 and 255.

DSCP

DSCP is an acronym for Differentiated Services Code Point. It is a field in the header of IP packets for packet classification purposes.

E

EEE

EEE is an abbreviation for Energy Efficient Ethernet defined in IEEE 802.3az.

EPS

EPS is an abbreviation for Ethernet Protection Switching defined in ITU/T G.8031.

Ethernet Type

Ethernet Type, or EtherType, is a field in the Ethernet MAC header, defined by the Ethernet networking standard. It is used to indicate which protocol is being transported in an Ethernet frame.

F

FTP

FTP is an acronym for File Transfer Protocol. It is a transfer protocol that uses the Transmission Control Protocol (TCP) and provides file writing and reading. It also provides directory service and security features.

Fast Leave

Multicast snooping Fast Leave processing allows the switch to remove an interface from the forwarding-table entry without first sending out group specific queries to the interface. The VLAN interface is pruned from the multicast tree for the multicast group specified in the original leave message. Fast-leave processing ensures optimal bandwidth management for all hosts on a switched network, even when multiple multicast groups are in use simultaneously. This processing applies to IGMP and MLD.

H

HTTP

HTTP is an acronym for Hypertext Transfer Protocol. It is a protocol that used to transfer or convey information on the World Wide Web (WWW).

HTTP defines how messages are formatted and transmitted, and what actions Web servers and browsers should take in response to various commands. For example, when you enter a URL in your browser, this actually sends an HTTP command to the Web server directing it to fetch and transmit the requested Web page. The other main standard that controls how the World Wide Web works is HTML, which covers how Web pages are formatted and displayed.

Any Web server machine contains, in addition to the Web page files it can serve, an HTTP daemon, a program that is designed to wait for HTTP requests and handle them when they arrive. The Web browser is an HTTP client, sending requests to server machines. An HTTP client initiates a request by establishing a Transmission Control Protocol (TCP) connection to a particular port on a remote host (port 80 by default). An HTTP server listening on that port waits for the client to send a request message.

HTTPS

HTTPS is an acronym for Hypertext Transfer Protocol over Secure Socket Layer. It is used to indicate a secure HTTP connection.

HTTPS provide authentication and encrypted communication and is widely used on the World Wide Web for security-sensitive communication such as payment transactions and corporate logons.

HTTPS is really just the use of Netscape's Secure Socket Layer (SSL) as a sublayer under its regular HTTP application layering. (HTTPS uses port 443 instead of HTTP port 80 in its interactions with the lower layer, TCP/IP.) SSL uses a 40-bit key size for the RC4 stream encryption algorithm, which is considered an adequate degree of encryption for commercial exchange.

I

ICMP

ICMP is an acronym for Internet Control Message Protocol. It is a protocol that generated the error response, diagnostic or routing purposes. ICMP messages generally contain information about routing difficulties or simple exchanges such as time-stamp or echo transactions. For example, the PING command uses ICMP to test an Internet connection.

IEEE 802.1X

IEEE 802.1X is an IEEE standard for port-based Network Access Control. It provides authentication to devices attached to a LAN port, establishing a point-to-point connection or preventing access from that port if authentication fails. With 802.1X, access to all switch ports can be centrally controlled from a server, which means that authorized users can use the same credentials for authentication from any point within the network.

IGMP

IGMP is an acronym for Internet Group Management Protocol. It is a communications protocol used to manage the membership of Internet Protocol multicast groups. IGMP is used by IP hosts and adjacent multicast routers to establish multicast group memberships. It is an integral part of the IP multicast specification, like ICMP for unicast connections. IGMP can be used for online video and gaming, and allows more efficient use of resources when supporting these uses.

IGMP Querier

A router sends IGMP Query messages onto a particular link. This router is called the Querier.

IMAP

IMAP is an acronym for Internet Message Access Protocol. It is a protocol for email clients to retrieve email messages from a mail server.

IMAP is the protocol that IMAP clients use to communicate with the servers, and SMTP is the protocol used to transport mail to an IMAP server.

The current version of the Internet Message Access Protocol is IMAP4. It is similar to Post Office Protocol version 3 (POP3), but offers additional and more complex features. For example, the IMAP4 protocol leaves your email messages on the server rather than downloading them to your computer. If you wish to remove your messages from the server, you must use your mail client to generate local folders, copy messages to your local hard drive, and then delete and expunge the messages from the server.

IP

IP is an acronym for Internet Protocol. It is a protocol used for communicating data across an internet network.

IP is a "best effort" system, which means that no packet of information sent over is assured to reach its destination in the same condition it was sent. Each device connected to a Local Area Network (LAN) or Wide Area Network (WAN) is given an Internet Protocol address, and this IP address is used to identify the device uniquely among all other devices connected to the extended network.

The current version of the Internet protocol is IPv4, which has 32-bits Internet Protocol addresses allowing for in excess of four billion unique addresses. This number is reduced drastically by the practice of webmasters taking addresses in large blocks, the bulk of which remain unused. There is a rather substantial movement to adopt a new version of

the Internet Protocol, IPv6, which would have 128-bits Internet Protocol addresses. This number can be represented roughly by a three with thirty-nine zeroes after it. However, IPv4 is still the protocol of choice for most of the Internet.

IPMC

IPMC is an acronym for IP MultiCast.

IP Source Guard

IP Source Guard is a secure feature used to restrict IP traffic on DHCP snooping untrusted ports by filtering traffic based on the DHCP Snooping Table or manually configured IP Source Bindings. It helps prevent IP spoofing attacks when a host tries to spoof and use the IP address of another host.

L

LACP

LACP is an IEEE 802.3ad standard protocol. The Link Aggregation Control Protocol, allows bundling several physical ports together to form a single logical port.

LLC

The IEEE 802.2 Logical Link Control (LLC) protocol provides a link mechanism for upper layer protocols. It is the upper sub-layer of the Data Link Layer and provides multiplexing mechanisms that make it possible for several network protocols (IP, IPX) to coexist within a multipoint network. LLC header consists of 1 byte DSAP (Destination Service Access Point), 1 byte SSAP (Source Service Access Point), 1 or 2 bytes Control field followed by LLC information.

LLDP

LLDP is an IEEE 802.1ab standard protocol.

The Link Layer Discovery Protocol(LLDP) specified in this standard allows stations attached to an IEEE 802 LAN to advertise, to other stations attached to the same IEEE 802 LAN, the major capabilities provided by the system incorporating that station, the management address or addresses of the entity or entities that provide management of those capabilities, and the identification of the stations point of attachment to the IEEE 802 LAN required by those management entity or entities. The information distributed via this protocol is stored by its recipients in a standard Management Information Base (MIB), making it possible for the information to be accessed by a Network Management System (NMS) using a management protocol such as the Simple Network Management Protocol (SNMP).

LLDP-MED

LLDP-MED is an extension of IEEE 802.1ab and is defined by the telecommunication industry association (TIA-1057).

LOC

LOC is an acronym for Loss Of Connectivity and is detected by a MEP and is indicating lost connectivity in the network. Can be used as a switch criteria by EPS

M

MAC Table

Switching of frames is based upon the DMAC address contained in the frame. The switch builds up a table that maps MAC addresses to switch ports for knowing which ports the frames should go to (based upon the DMAC address in the frame). This table contains both static and dynamic entries. The static entries are configured by the network administrator if the administrator wants to do a fixed mapping between the DMAC address and switch ports.

The frames also contain a MAC address (SMAC address), which shows the MAC address of the equipment sending the frame. The SMAC address is used by the switch to automatically update the MAC table with these dynamic MAC addresses. Dynamic entries are removed from the MAC table if no frame with the corresponding SMAC address have been seen after a configurable age time.

MEP

MEP is an acronym for Maintenance Entity Endpoint and is an endpoint in a Maintenance Entity Group (ITU-T Y.1731).

MD5

MD5 is an acronym for Message-Digest algorithm 5. MD5 is a message digest algorithm, used cryptographic hash function with a 128-bit hash value. It was designed by Ron Rivest in 1991. MD5 is officially defined in RFC 1321 - The MD5 Message-Digest Algorithm.

Mirroring

For debugging network problems or monitoring network traffic, the switch system can be configured to mirror frames from multiple ports to a mirror port. (In this context, mirroring a frame is the same as copying the frame.)

Both incoming (source) and outgoing (destination) frames can be mirrored to the mirror port.

MLD

MLD is an acronym for Multicast Listener Discovery for IPv6. MLD is used by IPv6 routers to discover multicast listeners on a directly attached link, much as IGMP is used in IPv4. The protocol is embedded in ICMPv6 instead of using a separate protocol.

MVR

Multicast VLAN Registration (MVR) is a protocol for Layer 2 (IP)-networks that enables multicast-traffic from a source VLAN to be shared with subscriber-VLANs.

The main reason for using MVR is to save bandwidth by preventing duplicate multicast streams being sent in the core network, instead the stream(s) are received on the MVR-VLAN and forwarded to the VLANs where hosts have requested it/them(Wikipedia).

N

NAS

NAS is an acronym for Network Access Server. The NAS is meant to act as a gateway to guard access to a protected source. A client connects to the NAS, and the NAS connects to another resource asking whether the client's supplied credentials are valid. Based on the answer, the NAS then allows or disallows access to the protected resource. An example of a NAS implementation is IEEE 802.1X.

NetBIOS

NetBIOS is an acronym for Network Basic Input/Output System. It is a program that allows applications on separate computers to communicate within a Local Area Network (LAN), and it is not supported on a Wide Area Network (WAN).

The NetBIOS giving each computer in the network both a NetBIOS name and an IP address corresponding to a different host name, provides the session and transport services described in the Open Systems Interconnection (OSI) model.

NFS

NFS is an acronym for Network File System. It allows hosts to mount partitions on a remote system and use them as though they are local file systems.

NFS allows the system administrator to store resources in a central location on the network, providing authorized users continuous access to them, which means NFS supports sharing of files, printers, and other resources as persistent storage over a computer network.

NTP

NTP is an acronym for Network Time Protocol, a network protocol for synchronizing the clocks of computer systems. NTP uses UDP (datagrams) as transport layer.

O

OAM

OAM is an acronym for Operation Administration and Maintenance.

It is a protocol described in ITU-T Y.1731 used to implement carrier ethernet functionality. MEP functionality like CC and RDI is based on this

Optional TLVs.

A LLDP frame contains multiple TLVs

For some TLVs it is configurable if the switch shall include the TLV in the LLDP frame. These TLVs are known as optional TLVs. If an optional TLVs is disabled the corresponding information is not included in the LLDP frame.

OUI

OUI is the organizationally unique identifier. An OUI address is a globally unique identifier assigned to a vendor by IEEE. You can determine which vendor a device belongs to according to the OUI address which forms the first 24 bits of a MAC address.

P

PCP

PCP is an acronym for Priority Code Point. It is a 3-bit field storing the priority level for the 802.1Q frame. It is also known as User Priority.

PHY

PHY is an abbreviation for Physical Interface Transceiver and is the device that implement the Ethernet physical layer (IEEE-802.3).

PING

ping is a program that sends a series of packets over a network or the Internet to a specific computer in order to generate a response from that computer. The other computer responds with an acknowledgment that it received the packets. Ping was created to verify whether a specific computer on a network or the Internet exists and is connected.

ping uses Internet Control Message Protocol (ICMP) packets. The PING Request is the packet from the origin computer, and the PING Reply is the packet response from the target.

Policer

A policer can limit the bandwidth of received frames. It is located in front of the ingress queue.

POP3

POP3 is an acronym for Post Office Protocol version 3. It is a protocol for email clients to retrieve email messages from a mail server.

POP3 is designed to delete mail on the server as soon as the user has downloaded it. However, some implementations allow users or an administrator to specify that mail be saved for some period of time. POP can be thought of as a "store-and-forward" service.

An alternative protocol is Internet Message Access Protocol (IMAP). IMAP provides the user with more capabilities for retaining e-mail on the server and for organizing it in folders on the server. IMAP can be thought of as a remote file server.

POP and IMAP deal with the receiving of e-mail and are not to be confused with the Simple Mail Transfer Protocol (SMTP). You send e-mail with SMTP, and a mail handler receives it on your recipient's behalf. Then the mail is read using POP or IMAP. IMAP4 and POP3 are the two most prevalent Internet standard protocols for e-mail retrieval. Virtually all modern e-mail clients and servers support both.

Private VLAN

In a private VLAN, communication between ports in that private VLAN is not permitted. A VLAN can be configured as a private VLAN.

PTP

PTP is an acronym for Precision Time Protocol, a network protocol for synchronizing the clocks of computer systems.

Q

QCE

QCE is an acronym for QoS Control Entry. It describes QoS class associated with a particular QCE ID.

There are six QCE frame types: Ethernet Type, VLAN, UDP/TCP Port, DSCP, TOS, and Tag Priority. Frames can be classified by one of 4 different QoS classes: "Low", "Normal", "Medium", and "High" for individual application.

QCL

QCL is an acronym for QoS Control List. It is the list table of QCEs, containing QoS control entries that classify to a specific QoS class on specific traffic objects.

Each accessible traffic object contains an identifier to its QCL. The privileges determine specific traffic object to specific QoS class.

QL

QL In SyncE this is the Quality Level of a given clock source. This is received on a port in a SSM indicating the quality of the clock received in the port.

QoS

QoS is an acronym for Quality of Service. It is a method to guarantee a bandwidth relationship between individual applications or protocols.

A communications network transports a multitude of applications and data, including high-quality video and delay-sensitive data such as real-time voice. Networks must provide secure, predictable, measurable, and sometimes guaranteed services.

Achieving the required QoS becomes the secret to a successful end-to-end business solution. Therefore, QoS is the set of techniques to manage network resources.

R

RARP

RARP is an acronym for Reverse Address Resolution Protocol. It is a protocol that is used to obtain an IP address for a given hardware address, such as an Ethernet address. RARP is the complement of ARP.

RADIUS

RADIUS is an acronym for Remote Authentication Dial In User Service. It is a networking protocol that provides centralized access, authorization and accounting management for people or computers to connect and use a network service.

RDI

RDI is an acronym for Remote Defect Indication. It is a OAM functionality that is used by a MEP to indicate defect detected to the remote peer MEP

RSTP

In 1998, the IEEE with document 802.1w introduced an evolution of STP: the Rapid Spanning Tree Protocol, which provides for faster spanning tree convergence after a topology change. Standard IEEE 802.1D-2004 now incorporates RSTP and obsoletes STP, while at the same time being backwards-compatible with STP.

S

SHA

SHA is an acronym for Secure Hash Algorithm. It designed by the National Security Agency (NSA) and published by the NIST as a U.S. Federal Information Processing Standard. Hash algorithms compute a fixed-length digital representation (known as a message digest) of an input data sequence (the message) of any length.

Shaper

A shaper can limit the bandwidth of transmitted frames. It is located after the ingress queues.

SMTP

SMTP is an acronym for Simple Mail Transfer Protocol. It is a text-based protocol that uses the Transmission Control Protocol (TCP) and provides a mail service modeled on the FTP file transfer service. SMTP transfers mail messages between systems and notifications regarding incoming mail.

SNAP

The SubNetwork Access Protocol (SNAP) is a mechanism for multiplexing, on networks using IEEE 802.2 LLC, more protocols than can be distinguished by the 8-bit 802.2 Service Access Point (SAP) fields. SNAP supports identifying protocols by Ethernet type field values; it also supports vendor-private protocol identifier.

SNMP

SNMP is an acronym for Simple Network Management Protocol. It is part of the Transmission Control Protocol/Internet Protocol (TCP/IP) protocol for network management. SNMP allow diverse network objects to participate in a network management architecture. It enables network management systems to learn network problems by receiving traps or change notices from network devices implementing SNMP.

SNTP

SNTP is an acronym for Simple Network Time Protocol, a network protocol for synchronizing the clocks of computer systems. SNTP uses UDP (datagrams) as transport layer.

SPROUT

Stack Protocol using ROUting Technology. An advanced protocol for almost instantaneous discovery of topology changes within a stack as well as election of a master switch. SPROUT also calculates parameters for setting up each switch to perform shortest path forwarding within the stack.

SSID

Service Set Identifier is a name used to identify the particular 802.11 wireless LANs to which a user wants to attach. A client device will receive broadcast messages from all access points within range advertising their SSIDs, and can choose one to connect to based on pre-configuration, or by displaying a list of SSIDs in range and asking the user to select one (wikipedia).

SSH

SSH is an acronym for Secure SHell. It is a network protocol that allows data to be exchanged using a secure channel between two networked devices. The encryption used by SSH provides confidentiality and integrity of data over an insecure network. The goal of SSH was to replace the earlier rlogin, TELNET and rsh protocols, which did not provide strong authentication or guarantee confidentiality (Wikipedia).

SSM

SSM In SyncE this is an abbreviation for Synchronization Status Message and is containing a QL indication.

STP

Spanning Tree Protocol is an OSI layer-2 protocol which ensures a loop free topology for any bridged LAN. The original STP protocol is now obsolete by RSTP.

Switch ID

Switch IDs (1-16) are used to uniquely identify the switches within a stack. The Switch ID of each switch is shown on the display on the front of the switch and is used widely in the web pages as well as in the CLI commands.

SyncE

SyncE is an abbreviation for Synchronous Ethernet. This functionality is used to make a network 'clock frequency' synchronized. Not to be confused with real time clock synchronized (IEEE 1588).

T

TACACS+

TACACS+ is an acronym for Terminal Access Controller Access Control System Plus. It is a networking protocol which provides access control for routers, network access servers and other networked computing devices via one or more centralized servers. TACACS+ provides separate authentication, authorization and accounting services.

Tag Priority

Tag Priority is a 3-bit field storing the priority level for the 802.1Q frame.

TCP

TCP is an acronym for Transmission Control Protocol. It is a communications protocol that uses the Internet Protocol (IP) to exchange the messages between computers.

The TCP protocol guarantees reliable and in-order delivery of data from sender to receiver and distinguishes data for multiple connections by concurrent applications (for example, Web server and e-mail server) running on the same host.

The applications on networked hosts can use TCP to create connections to one another. It is known as a connection-oriented protocol, which means that a connection is established and maintained until such time as the message or messages to be exchanged by the application programs at each end have been exchanged. TCP is responsible for ensuring that a message is divided into the packets that IP manages and for reassembling the packets back into the complete message at the other end.

Common network applications that use TCP include the World Wide Web (WWW), e-mail, and File Transfer Protocol (FTP).

TELNET

TELNET is an acronym for TELetype NETwork. It is a terminal emulation protocol that uses the Transmission Control Protocol (TCP) and provides a virtual connection between TELNET server and TELNET client.

TELNET enables the client to control the server and communicate with other servers on the network. To start a Telnet session, the client user must log in to a server by entering a valid username and password. Then, the client user can enter commands through the Telnet program just as if they were entering commands directly on the server console.

TFTP

TFTP is an acronym for Trivial File Transfer Protocol. It is transfer protocol that uses the User Datagram Protocol (UDP) and provides file writing and reading, but it does not provide directory service and security features.

U

UDP

UDP is an acronym for User Datagram Protocol. It is a communications protocol that uses the Internet Protocol (IP) to exchange the messages between computers.

UDP is an alternative to the Transmission Control Protocol (TCP) that uses the Internet Protocol (IP). Unlike TCP, UDP does not provide the service of dividing a message into packet datagrams, and UDP doesn't provide reassembling and sequencing of the packets. This means that the application program that uses UDP must be able to make sure that the entire message has arrived and is in the right order. Network applications that want to save processing time because they have very small data units to exchange may prefer UDP to TCP.

UDP provides two services not provided by the IP layer. It provides port numbers to help distinguish different user requests and, optionally, a checksum capability to verify that the data arrived intact.

Common network applications that use UDP include the Domain Name System (DNS), streaming media applications such as IPTV, Voice over IP (VoIP), and Trivial File Transfer Protocol (TFTP).

User Priority

User Priority is a 3-bit field storing the priority level for the 802.1Q frame. It is also known as PCP.

V

VLAN

Virtual LAN. A method to restrict communication between switch ports. VLANs can be used for the following applications:

VLAN unaware switching: This is the default configuration. All ports are VLAN unaware with Port VLAN ID 1 and members of VLAN 1. This means that MAC addresses are learned in VLAN 1, and the switch does not remove or insert VLAN tags.

VLAN aware switching: This is based on the IEEE 802.1Q standard. All ports are VLAN aware. Ports connected to VLAN aware switches are members of multiple VLANs and transmit tagged frames. Other ports are members of one VLAN, set up with this Port VLAN ID, and transmit untagged frames.

Provider switching: This is also known as Q-in-Q switching. Ports connected to subscribers are VLAN unaware, members of one VLAN, and set up with this unique Port VLAN ID. Ports connected to the service provider are VLAN aware, members of multiple VLANs, and set up to tag all frames. Untagged frames received on a subscriber port are forwarded to the provider port with a single VLAN tag. Tagged frames received on a subscriber port are forwarded to the provider port with a double VLAN tag.

VLAN ID

VLAN ID is a 12-bit field specifying the VLAN to which the frame belongs.

Voice VLAN

Voice VLAN is VLAN configured specially for voice traffic. By adding the ports with voice devices attached to voice VLAN, we can perform QoS-related configuration for voice data, ensuring the transmission priority of voice traffic and voice quality.

